

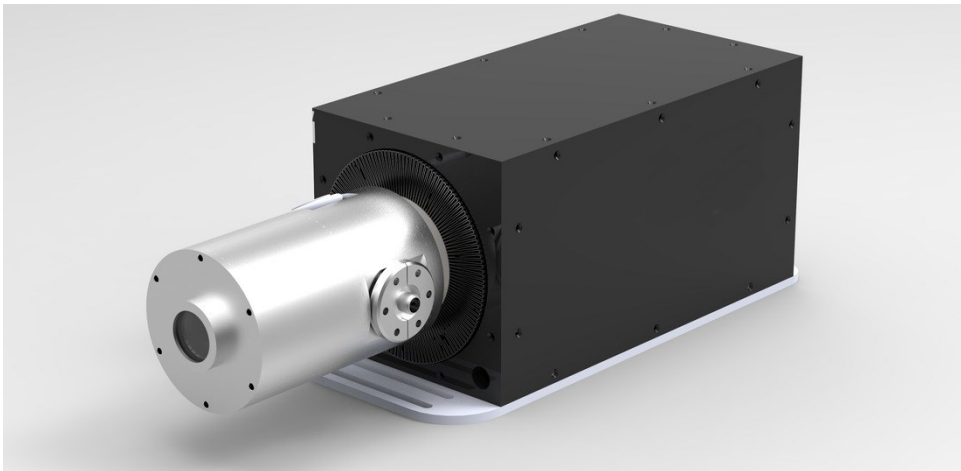

QCL Housing-110 Versatile Laboratory Platform



2022 V1

For customized projects please Contact us:

info@simtrum.com

QCL Housing-110 Versatile Laboratory Platform

The QCL Housing-110 system is a turnkey source of terahertz radiation that uses an integral Stirling Cycle cooler for cryogen-free and alignment-free operation. A range of user interchangeable multimode QCL modules is available providing milliwatt power levels at frequencies between 1.8 to 5 THz. The QCL Housing-110 now has a multi-QCL option, which integrates up to four, automatically switched QCLs in the same system.

Features

The QCL Housing-110 System Included

- QCL laser diode module
- Stirling Cycle Cooler
- QCL drive electronics capable of pulsed or continuous-wave operation ($<0.4 \mu\text{s}$ up to DC)

A variety of user-interchangeable QCL modules are available

- Milliwatt average power levels
- Continuous wave operation available at select frequencies
- Choice of center frequencies ranging from 1.8 to 5 THz
- Multimode operation
- Single-mode DFB devices available at 2/3/3.8/4.7 THz.

The QCL Housing-110 system is designed for ease of use:

- Cryogen-free – laser diode cooling is by a closed cycle refrigeration
- No optical alignment
- Maintenance-free
- Stirling cycle cooler is maintenance-free
- Laser bias is controlled by the front panel or computer (USB and Windows 7/10 compatible)
- Complete package is tabletop compact, portable and operates on 120/240 V (5A)

The QCL Housing-110 has double the cooling power of the QCL Housing-100 allowing the use of larger QCL devices: this effectively doubles the available output power.

Product Size

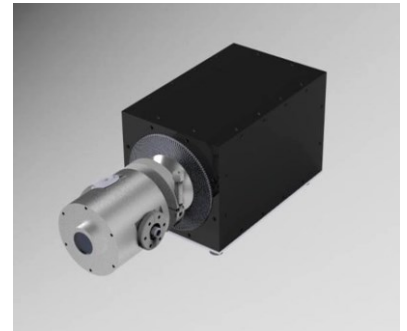
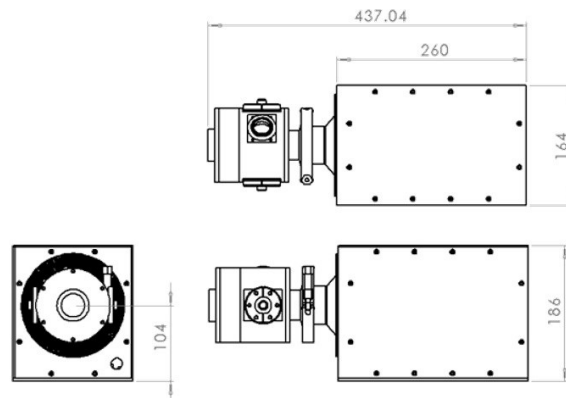

QCL Housing-110 System

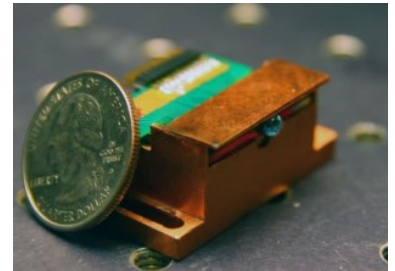

THz QCL Sub-mount

Technical Data

Laser Driver Specifications QCL Driver Electronics (FPO typical values)

Current	Up to 2 A
Voltage	Up to 100 V
Pulsed Width	0.2 μ s up to DC
Frequency	100 Hz to 100 kHz
Triggering	TTL Internal/External Gate BNC connector
Interface/Control	USB
Compatibility	Windows XP/Vista 7
Software Options	Laser bias current/voltage, pulse width, duty cycle and trigger source (internal external)
AC Voltage Range	100 - 125 / 200 - 240 V
Rated Frequency	50 - 60 Hz
Rated Current	120 V/5 A – 240 V/ 2.5 A

Stirling Cycle Cryocooler Specifications

Operation Temperature	Room Temperature, no cryogenes.
Cooldown Time	< 30 min to -50 K
Maintenance	The cold head requires periodic vacuum purge to -10^{-2} mBar with a provided compact vacuum pump (e.g. Edwards E2M0.7 or similar). No turbo pumping is required.

QCL Characteristics

Laser Diodes	Multimode and single-mode laser diodes are available.
Beam Divergence	from 5 to 35 degrees FWHM

* Select devices operable in continuous wave

General Paraments

AC Voltage Range	100-125 / 200-240V
Rated Frequency	50 / 60 Hz
Operating Modes	Closed / Open Loop, temperature control
Stirling Cooler MTTF	>200,000 Hours
Weight	5 Kg

Included Components

- QCL device(s) characterized for wavelength, output power, beam divergence and current versus voltage
- Vacuum chamber with electrical feedthroughs and vacuum gauge
- Liquid/Air cooled, Low-vibration stirling cycle cryocooler
- LWP-PS2 pulsed laser driver
- Compact rotary vane vacuum pump
- Laptop PC with software for control of the driver and cryocooler

Warranty

- One-year parts and labour

Multi-QCL Option

- The multi-QCL option allows up to 4 QCLs to be mounted in the cryocooler
- Devices are switched automatically using the LWP-DEMUX demultiplexing switch
- Beams are collimated and positioned using an HR silicon lens on a motorized 3-axis stage, LWP-STEP

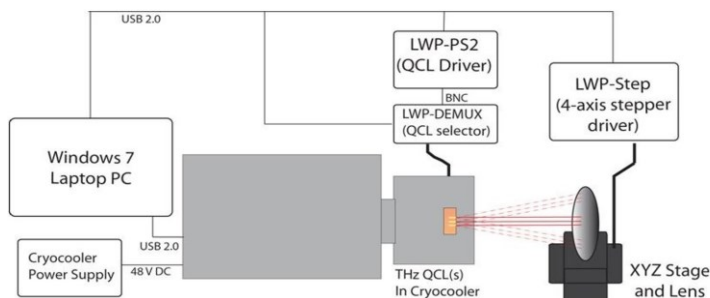

Typical Connection Diagram for multi-QCL option



QCL Housing-HP System with the Multi-QCL option with LWP-PS2 Driver

*Due to ongoing continuous product improvement, specifications are subject to change without notice.

Multi-mode THz QCLs

- Minimum average power levels are shown below when used in QCL Housing-100/110/1000 systems
- The QCL Housing-100/110/1000 systems permit the user to exchange devices allowing maximum experimental flexibility

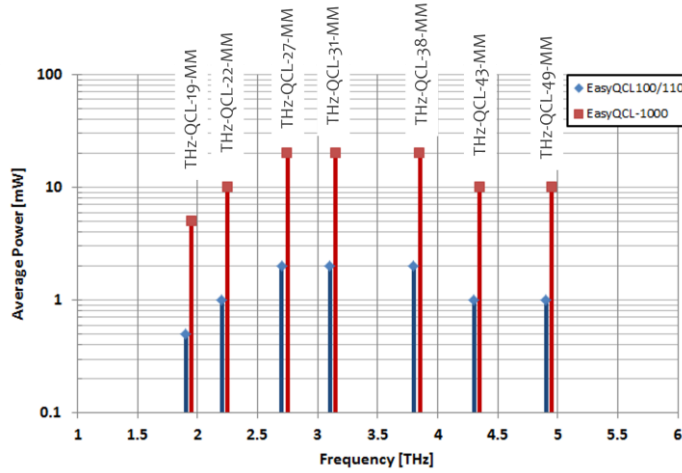

Technical Specification for Multi-mode 3.265 THz QCL Chip

Device Type	Fabry-Perot with Integrated Lens
Operating Mode	CW
Measurement Temp	48-49k
Lasing Frequency	3.265THz (see below)
CW Power	>6 mW (V = 15.0V, I = 155mA)
Absolute Max Current	155mA (at >15.2 V)

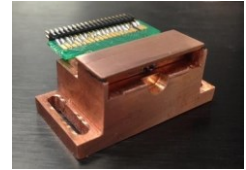
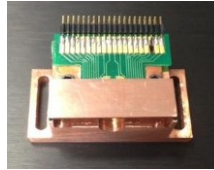

Current vs Voltage

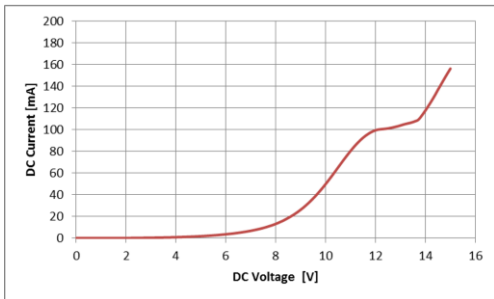

Spectral Characteristics

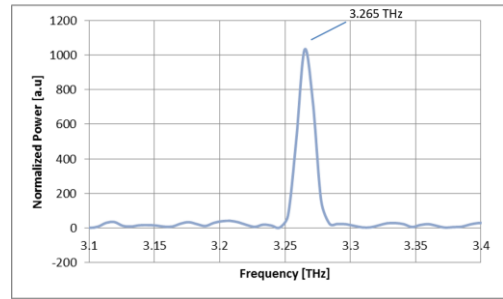

Pulse spectrum taken at 48K (V=12.8 V, I=225 mA)

Power vs Current

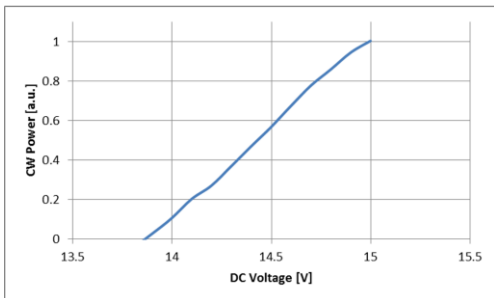

Focused Beam

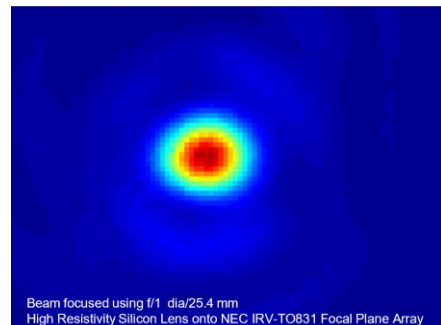

*Due to ongoing continuous product improvement, specifications are subject to change without notice.

Single-mode DFB THz QCLs

- Single-mode DFB devices are available with center frequencies of 2 THz, 3THz and 3.8THz
- Power levels are typical >1 mW CW power at the peak wavelength
- Available as single devices, or 20-element QCL arrays spanning > 80 GHz
- Customized fabrication available within \pm 6 GHz of the target frequency
- Minimum average power levels are shown below vs frequency when used in EASY QCL-100/110/1000 systems
- The QCL Housing-100/110/1000 systems permit the user to exchange devices allowing maximum experimental flexibility

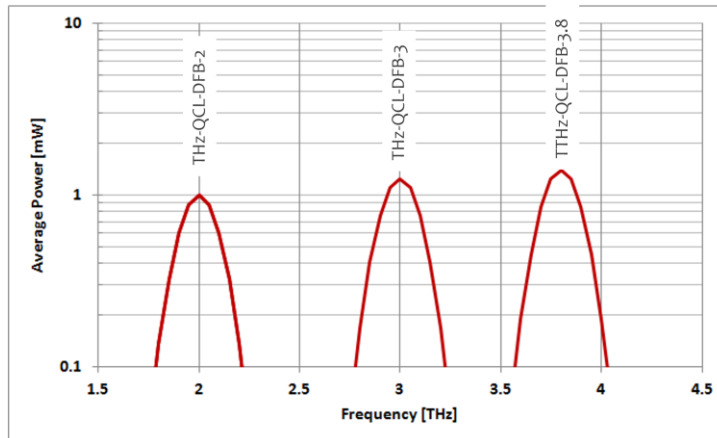

Technical Specification for Single-mode 3.1 THz QCL Chip

Device Type	Third-order DFB
Operating Mode	CW
Measurement Temp	45-48k
Lasing Frequency	Single-mode at 3.099THz (see below)
CW Power	2.3 mW ($V = 12.55V, I = 247mA$)
Absolute Max Current	255mA (at >12.7 V)

Current vs Voltage

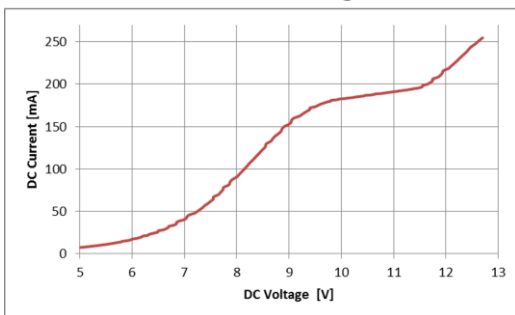

Spectral Characteristics

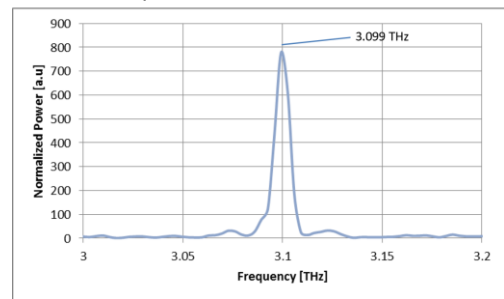

Pulse spectrum taken at 45K ($V=12.4 V, I=238 mA$)

Power vs Voltage

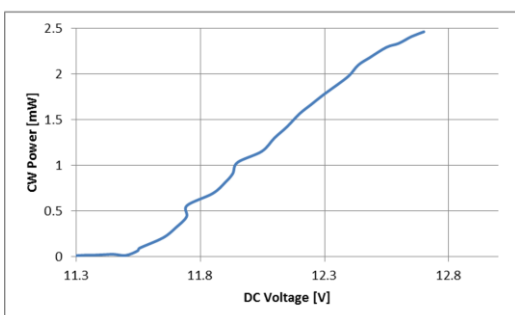

Typical Focused Beam

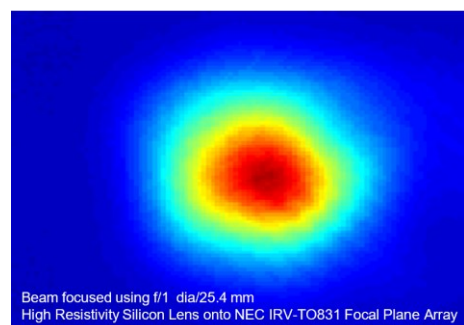

*Due to ongoing continuous product improvement, specifications are subject to change without notice.

Technical Specification for Tunable THz QCL Chip

Device Type	Electronically Controlled Tunable QCL
Operating Mode	Pulsed (2 μ s 100 kHz)
Measurement Temp	55K on QCL Housing-200 system
Lasing Frequency	Electronically Controlled Tuning from -1.5THz to 4.5 THz
Power	0.1 to 1 mW peak power in QCL Housing-200

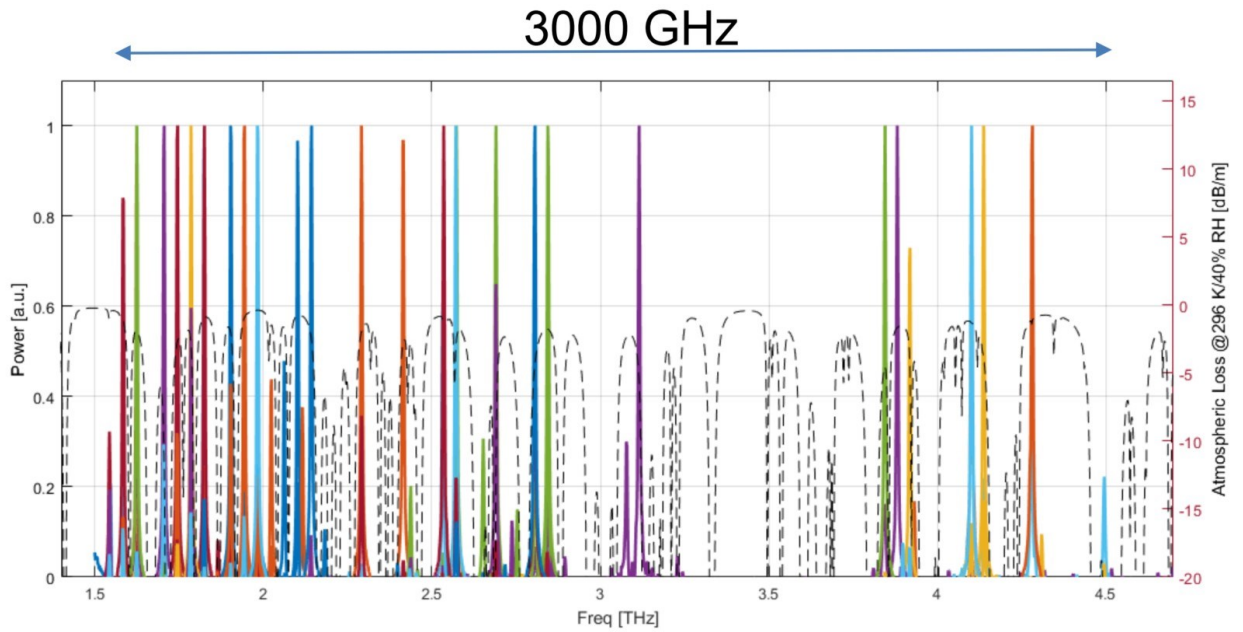

*Due to ongoing continuous product improvement, specifications are subject to change without notice.