

**FOR INFORMATION ONLY
NOT FOR MANUFACTURING PURPOSES**

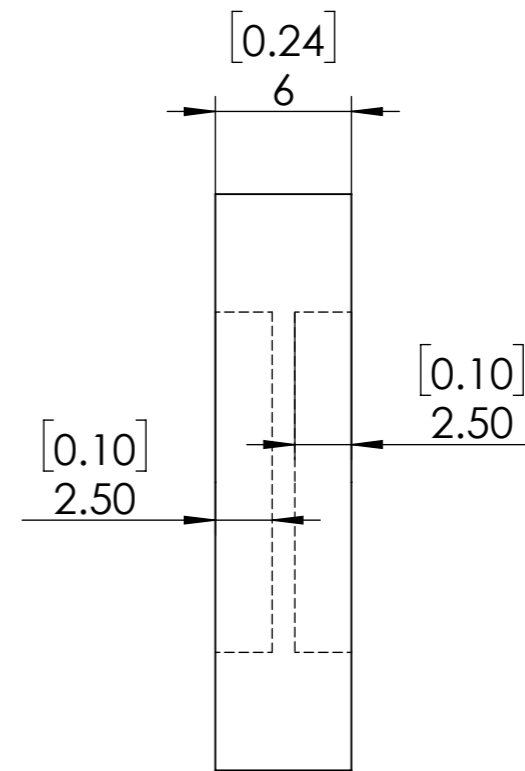
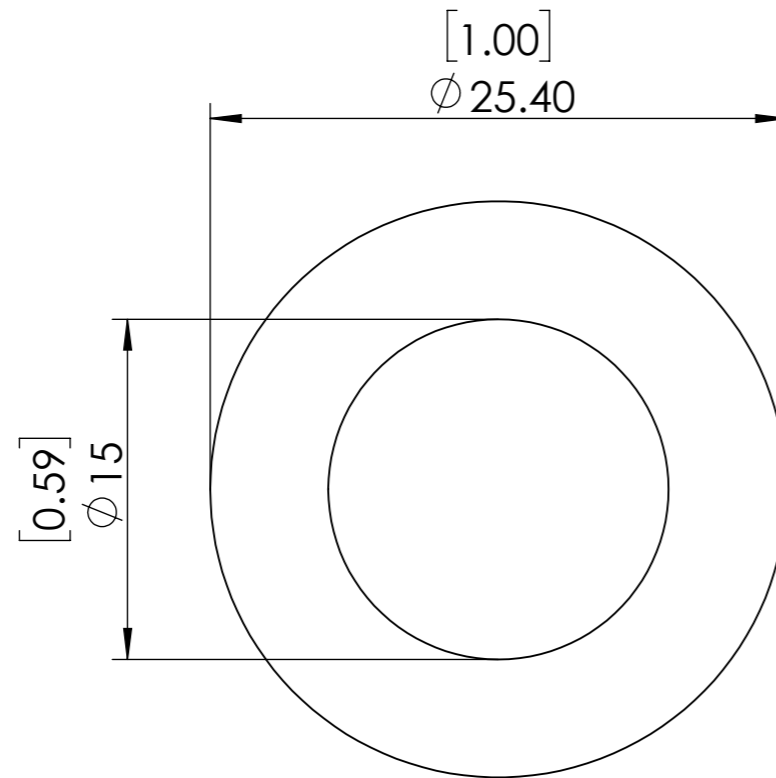
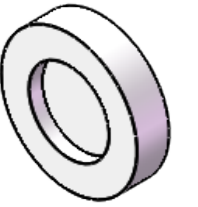

1. UNMOUNTED DIAMETER: 15 mm
2. DESIGN WAVELENGTH: 550-750 nm
3. RETARDATION: $\lambda/4$
4. RETARDATION TOLERANCE: $<\lambda/100$
5. WAVEFRONT DISTORTION: $<\lambda/4@633\text{nm}$
6. SURFACE QUALITY: 40/20
7. CLEAR APERTURE: 13.5mm
8. PARALLELISM: <10 arcsec
9. COATING: $R<1\%@550-750\text{nm}$

SIMTRUM www.simtrum.com	
Title:	Cemented Achromatic Quarter Waveplate
Material:	Quartz+MgF2
Part No:	QM-CAQWP-15-550-750-M