

**FOR INFORMATION ONLY  
NOT FOR MANUFACTURING PURPOSES**

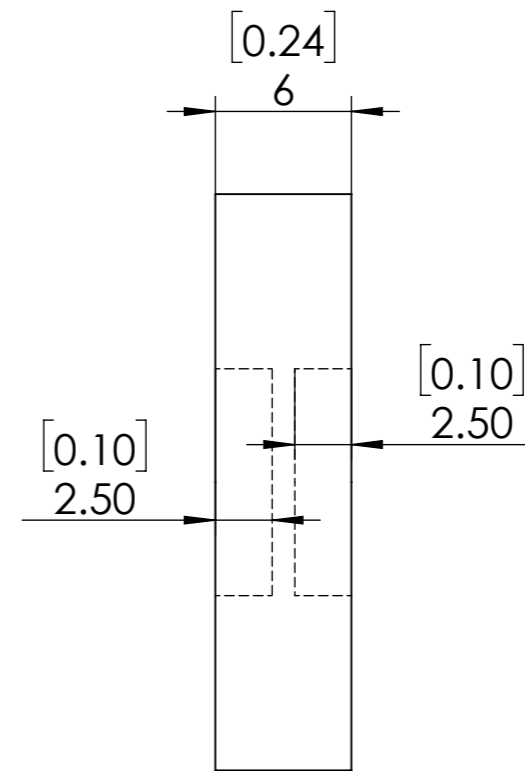
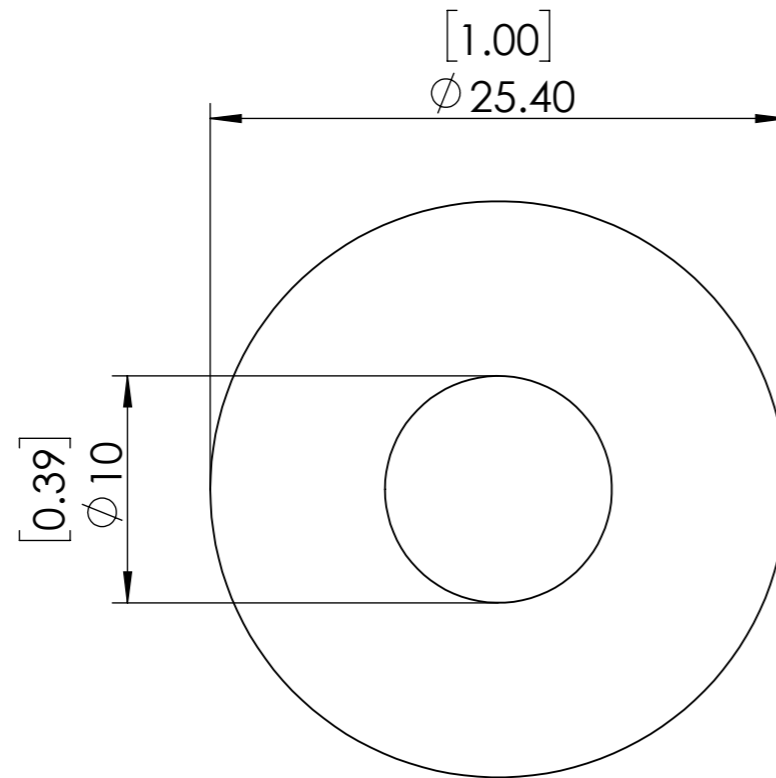
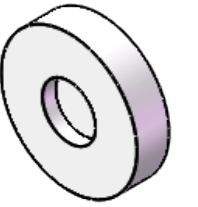

1. UNMOUNTED DIAMETER: 10 mm
2. DESIGN WAVELENGTH: 650-1100 nm
3. RETARDATION:  $\lambda/4$
4. RETARDATION TOLERANCE:  $<\lambda/100$
5. WAVEFRONT DISTORTION:  $<\lambda/4@633\text{nm}$
6. SURFACE QUALITY: 40/20
7. CLEAR APERTURE: 8mm
8. PARALLELISM:  $<10$  arcsec
9. COATING:  $R<1\%$  @650-1100nm

<b>SIMTRUM</b> www.simtrum.com	
Title:	Air Spaced Achromatic Quarter Waveplate
Material:	Quartz+MgF2
Part No:	QM-AAQWP-10-650-1100-M