

**FOR INFORMATION ONLY  
NOT FOR MANUFACTURING PURPOSES**

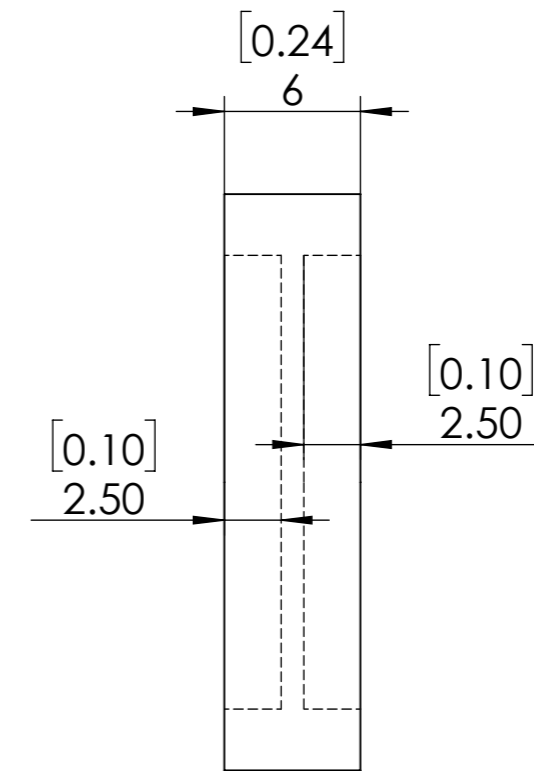
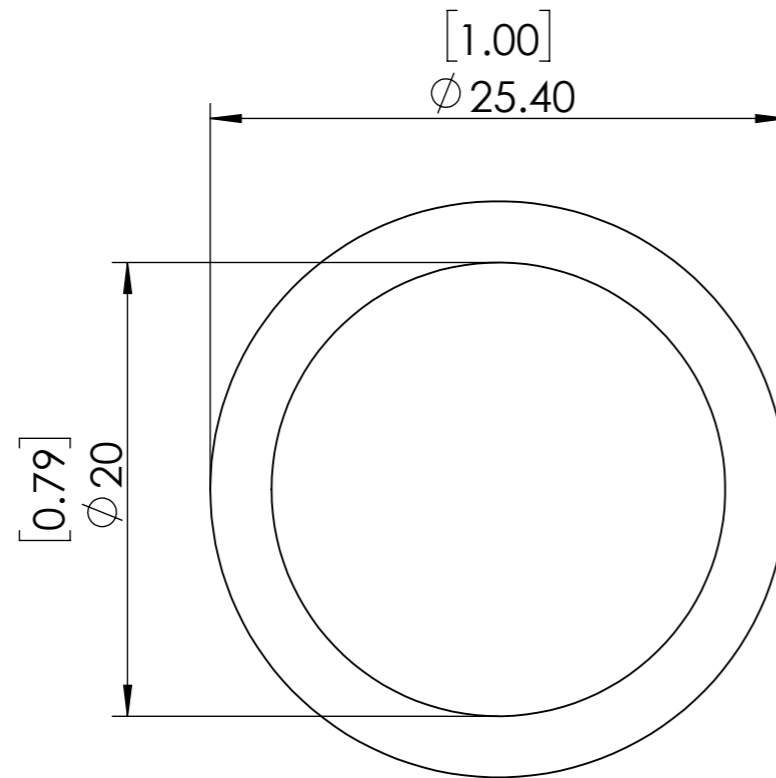
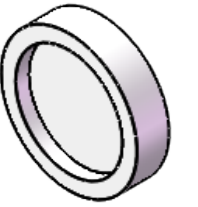

1. UNMOUNTED DIAMETER: 20
2. DESIGN WAVELENGTH: 450-650 nm
3. RETARDATION:  $\lambda/2$
4. RETARDATION TOLERANCE:  $<\lambda/100$
5. WAVEFRONT DISTORTION:  $<\lambda/4@633\text{nm}$
6. SURFACE QUALITY: 40/20
7. CLEAR APERTURE: 18mm
8. PARALLELISM:  $<10$  arcsec
9. COATING:  $R<1\%$  @450-650nm

<b>SIMTRUM</b> www.simtrum.com	
Title:	Cemented Achromatic Half Waveplate
Material:	Quartz+MgF2
Part No:	QM-CAHWP-20-450-650-M