

**FOR INFORMATION ONLY
NOT FOR MANUFACTURING PURPOSES**

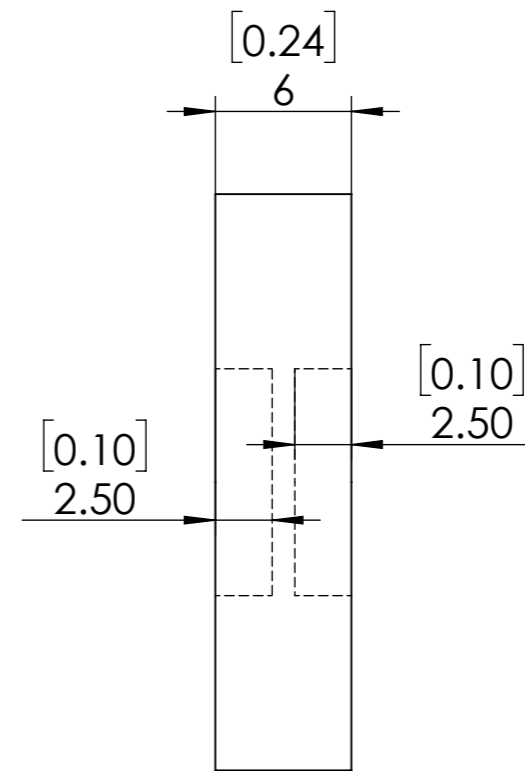
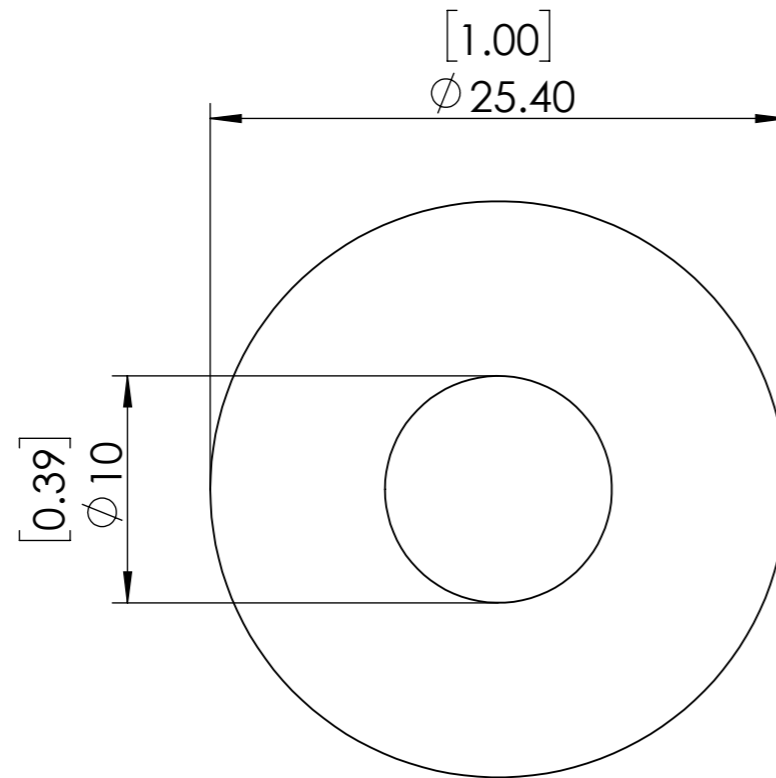
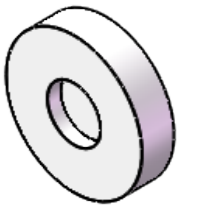

1. UNMOUNTED DIAMETER: 10
2. DESIGN WAVELENGTH: 650-1100 nm
3. RETARDATION: $\lambda/2$
4. RETARDATION TOLERANCE: $<\lambda/100$
5. WAVEFRONT DISTORTION: $<\lambda/4@633\text{nm}$
6. SURFACE QUALITY: 40/20
7. CLEAR APERTURE: 8mm
8. PARALLELISM: <10 arcsec
9. COATING: $R<1\%$ @650-1100nm

SIMTRUM www.simtrum.com	
Title:	Air Spaced Achromatic Half Waveplate
Material:	Quartz+MgF2
Part No:	QM-AAHWP-10-650-1100-M