

**FOR INFORMATION ONLY
NOT FOR MANUFACTURING PURPOSES**

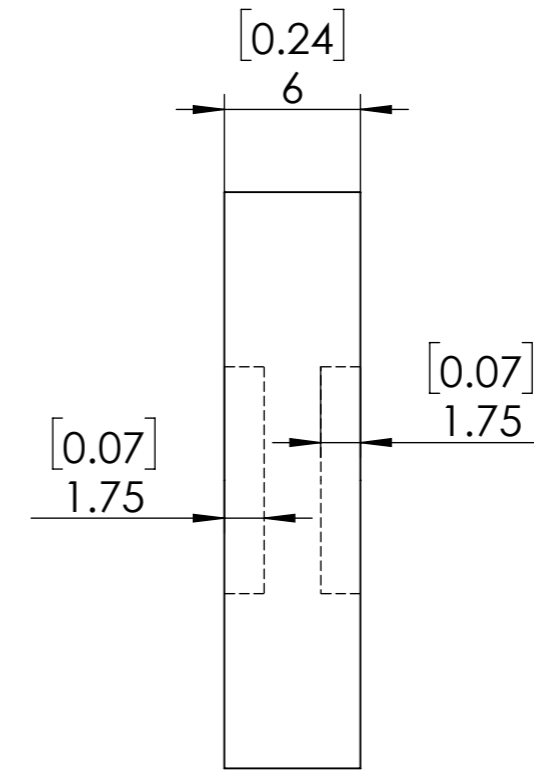
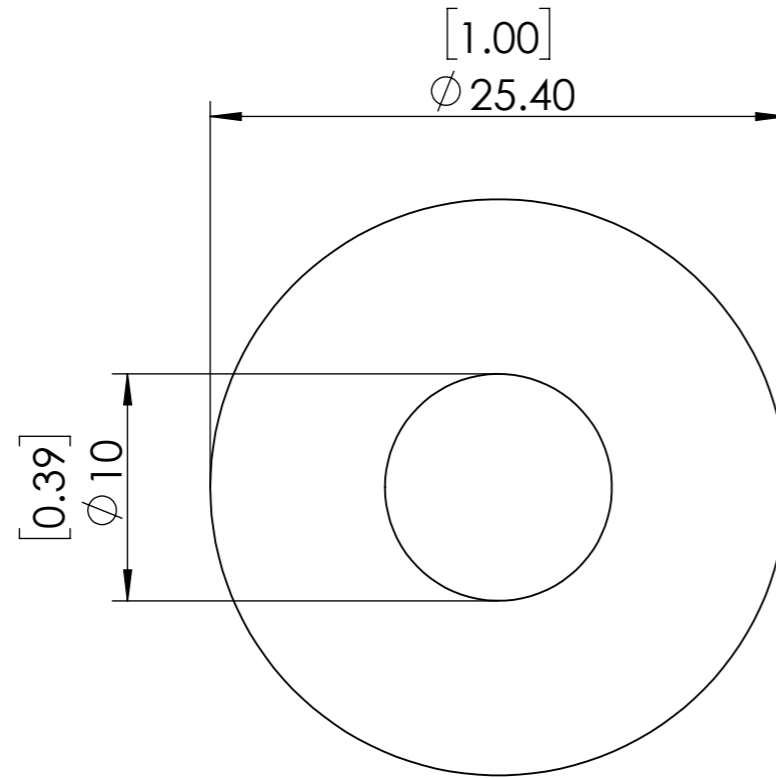
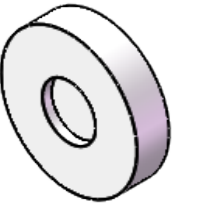

1. UNMOUNTED DIAMETER: 10 mm
2. DESIGN WAVELENGTH: 1550 nm
3. RETARDATION: $\lambda/4$
4. RETARDATION TOLERANCE: $<\lambda/300$
5. WAVEFRONT DISTORTION: $<\lambda/8@633\text{nm}$
6. SURFACE QUALITY: 20/10
7. CLEAR APERTURE: $>8\text{mm}$
8. PARALLELISM: <1 arcsec
9. COATING: $R<0.25\%@1550\text{nm}$

SIMTRUM www.simtrum.com	
Title:	Optically Contacted Zero Order Waveplate
Material:	Quartz
Part No:	Q-QZWP-R4-10-1550-M