

**FOR INFORMATION ONLY  
NOT FOR MANUFACTURING PURPOSES**

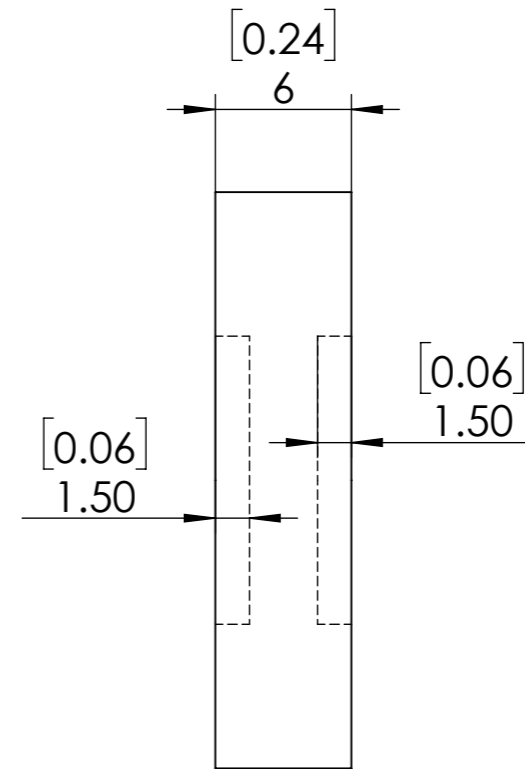
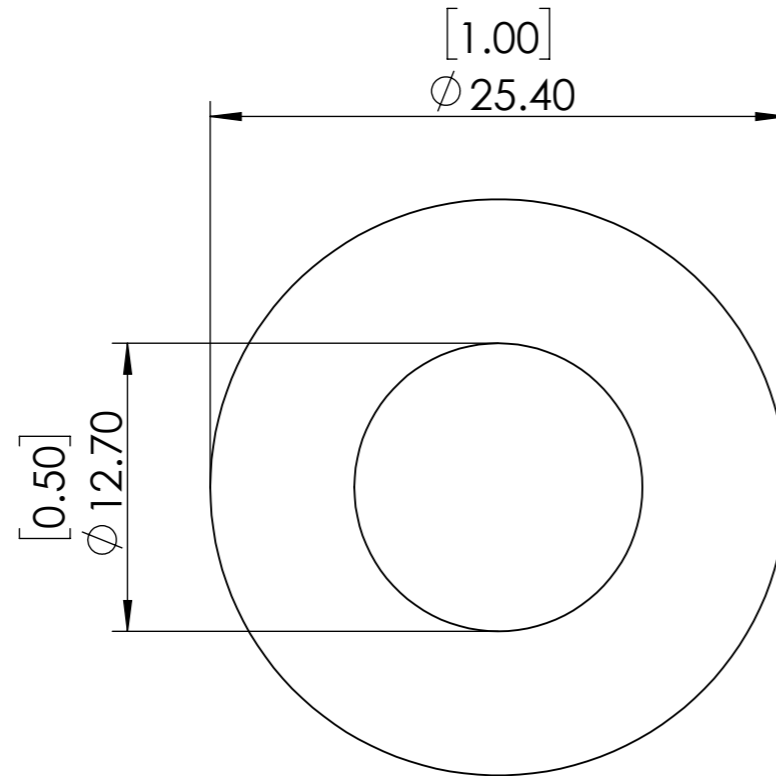

1. UNMOUNTED DIAMETER: 12.7 mm
2. DESIGN WAVELENGTH: 355 nm
3. RETARDATION:  $\lambda/4$
4. RETARDATION TOLERANCE:  $<\lambda/300$
5. WAVEFRONT DISTORTION:  $<\lambda/8@633\text{nm}$
6. SURFACE QUALITY: 20/10
7. CLEAR APERTURE:  $>11.5\text{mm}$
8. PARALLELISM:  $<1$  arcsec
9. COATING:  $R<0.25\%@355\text{nm}$

<b>SIMTRUM</b> www.simtrum.com	
Title:	Optically Contacted Zero Order Waveplate
Material:	Quartz
Part No:	Q-QZWP-R4-12.7-355-M