

**FOR INFORMATION ONLY
NOT FOR MANUFACTURING PURPOSES**

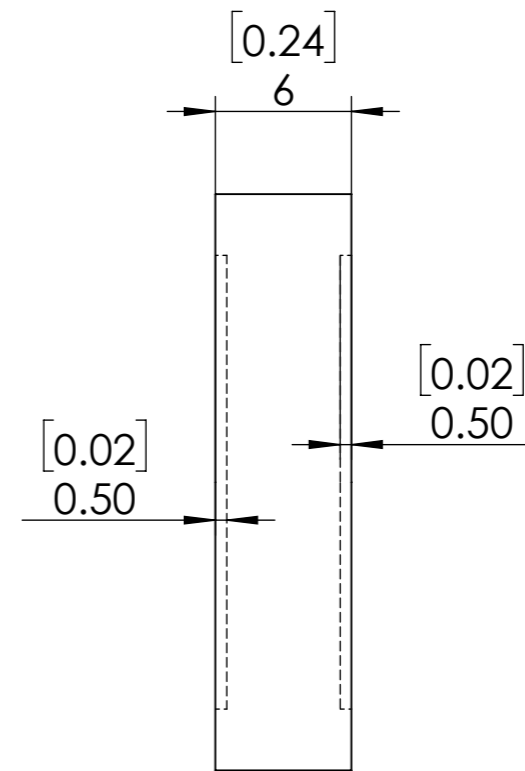
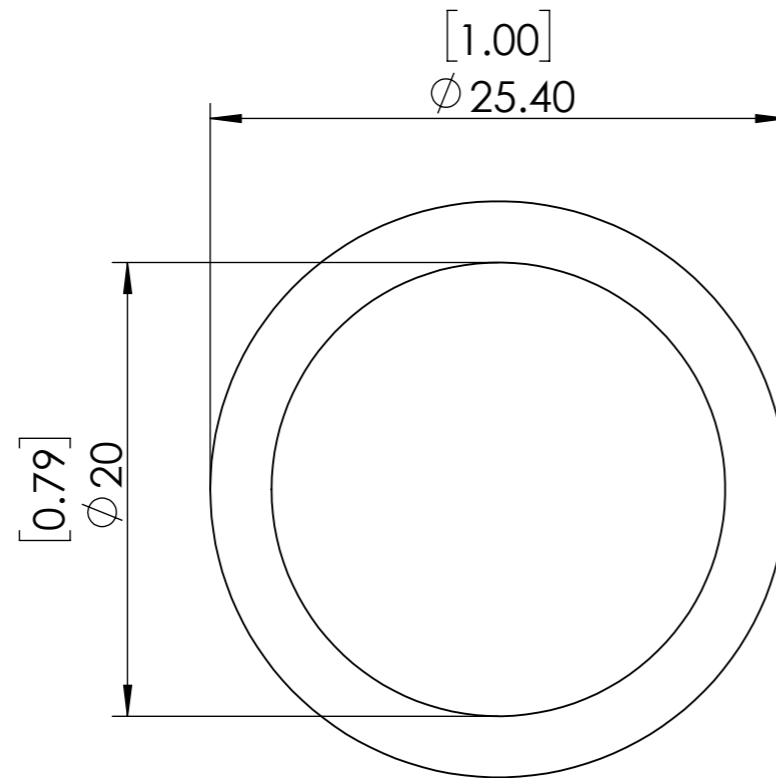

1. UNMOUNTED DIAMETER: 20
2. DESIGN WAVELENGTH: 355 nm
3. RETARDATION: $\lambda/2$
4. RETARDATION TOLERANCE: $<\lambda/100$
5. WAVEFRONT DISTORTION: $<\lambda/8@633\text{nm}$
6. SURFACE QUALITY: 20/10
7. CLEAR APERTURE: $>18\text{mm}$
8. PARALLELISM: <1 arcsec
9. COATING: $R<0.25\%@355\text{nm}$

| | |
|-----------------------------------|---|
| SIMTRUM www.simtrum.com | |
| Title: | Optically Contacted Zero Order Half Waveplate |
| Material: | Quartz |
| Part No: | Q-OZHWP-R2-20-355-M |