

**FOR INFORMATION ONLY
NOT FOR MANUFACTURING PURPOSES**

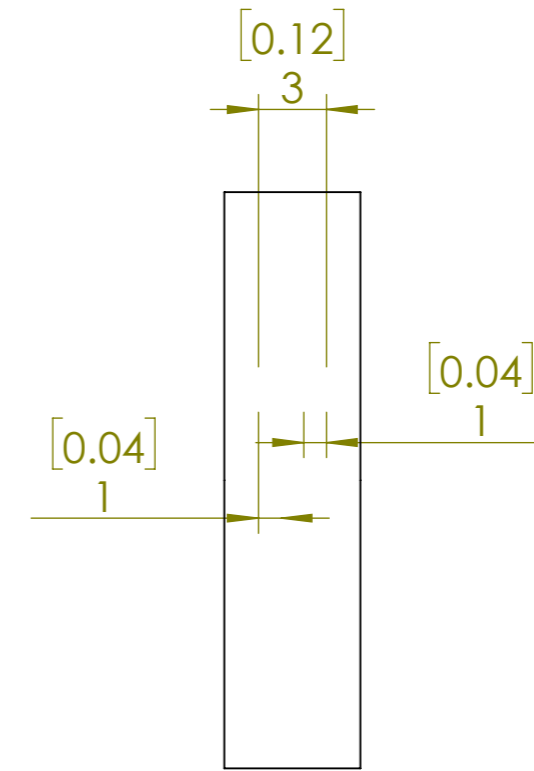
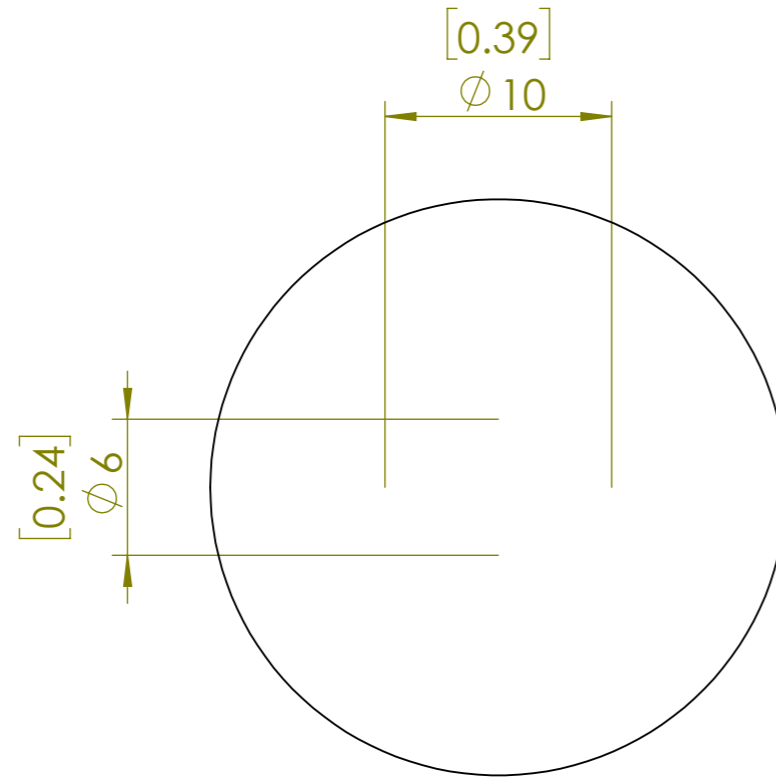
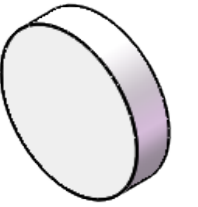

1. UNMOUNTED DIAMETER: 25.4
2. DESIGN WAVELENGTH: 633 nm
3. RETARDATION: $\lambda/2$
4. RETARDATION TOLERANCE: $<\lambda/300$
5. WAVEFRONT DISTORTION: $<\lambda/8@633\text{nm}$
6. SURFACE QUALITY: 20/10
7. CLEAR APERTURE: $>22.9\text{mm}$
8. PARALLELISM: <1 arcsec
9. COATING: $R<0.25\%@633\text{nm}$

SIMTRUM www.simtrum.com	
Title:	Optically Contacted Zero Order Half Waveplate
Material:	Quartz
Part No:	Q-OZHWP-R2-25.4-633-M