

**FOR INFORMATION ONLY  
NOT FOR MANUFACTURING PURPOSES**

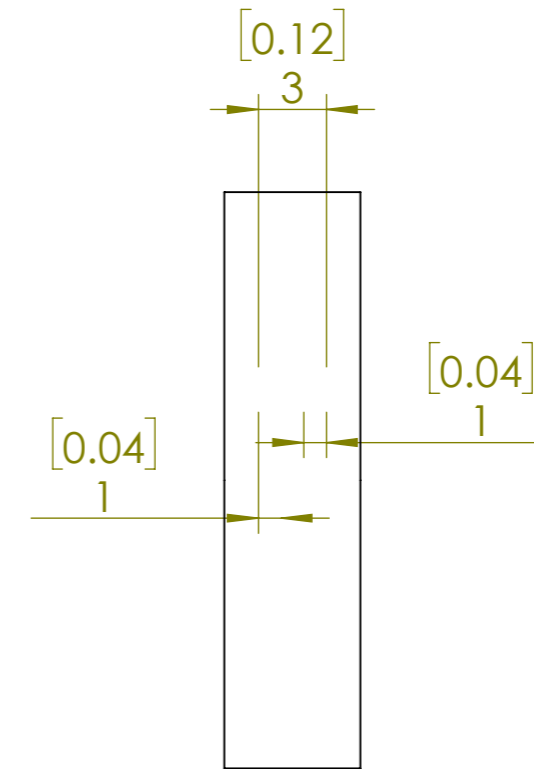
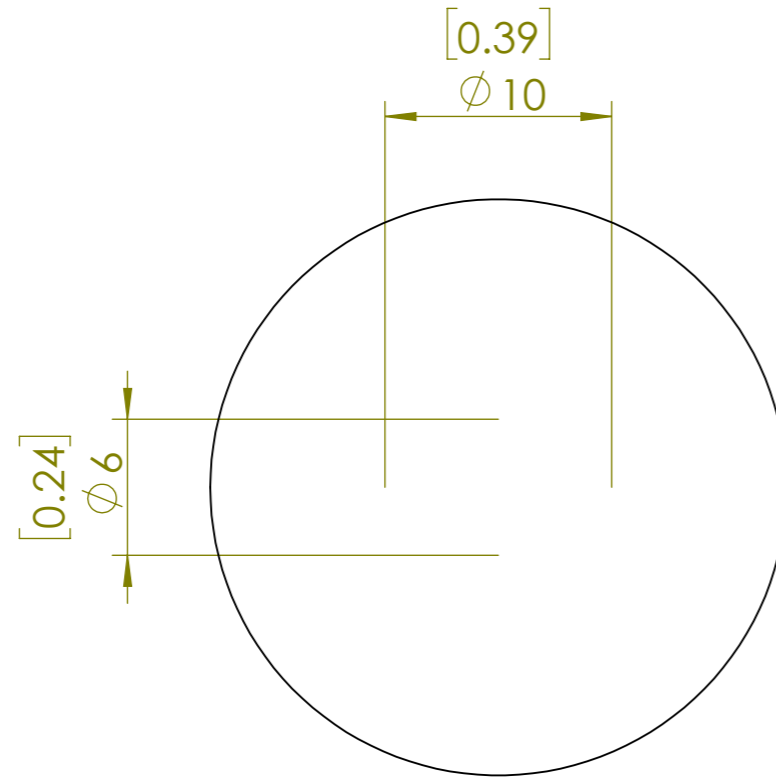
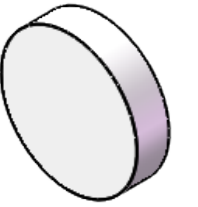

1. UNMOUNTED DIAMETER: 25.4
2. DESIGN WAVELENGTH: 852 nm
3. RETARDATION:  $\lambda/2$
4. RETARDATION TOLERANCE:  $<\lambda/300$
5. WAVEFRONT DISTORTION:  $<\lambda/8@633\text{nm}$
6. SURFACE QUALITY: 20/10
7. CLEAR APERTURE:  $>22.9\text{mm}$
8. PARALLELISM:  $<1$  arcsec
9. COATING:  $R<0.25\%@852\text{nm}$

<b>SIMTRUM</b> www.simtrum.com	
Title:	Optically Contacted Zero Order Half Waveplate
Material:	Quartz
Part No:	Q-OZHWP-R2-25.4-852-M