

**FOR INFORMATION ONLY
NOT FOR MANUFACTURING PURPOSES**

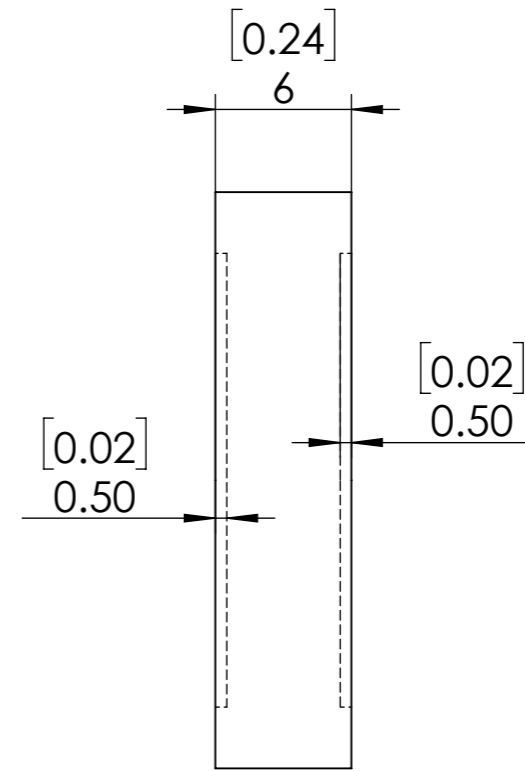
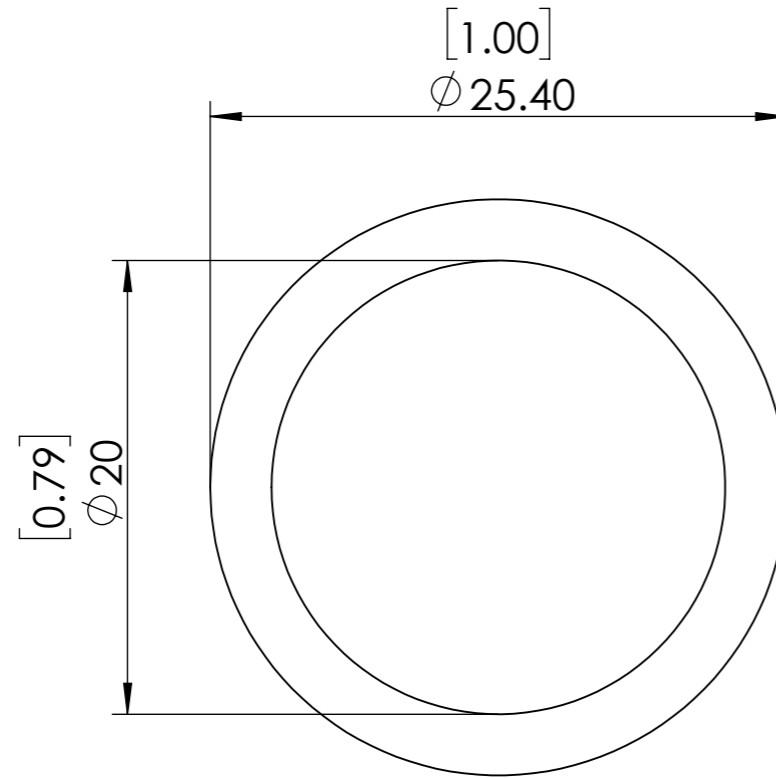

1. UNMOUNTED DIAMETER: 20
2. DESIGN WAVELENGTH: 800 nm
3. RETARDATION: $\lambda/2$
4. RETARDATION TOLERANCE: $\lambda/500$
5. WAVEFRONT DISTORTION: $<\lambda/8@633\text{nm}$
6. SURFACE QUALITY: 60/40
7. CLEAR APERTURE: 15mm
8. PARALLELISM: <3 arcsec
9. COATING: $R<0.25\%@800\text{nm}$

SIMTRUM www.simtrum.com	
Title:	Air Spaced Zero Order Half Waveplate
Material:	Quartz
Part No:	Q-AZHWP-20-800-M