

**FOR INFORMATION ONLY
NOT FOR MANUFACTURING PURPOSES**

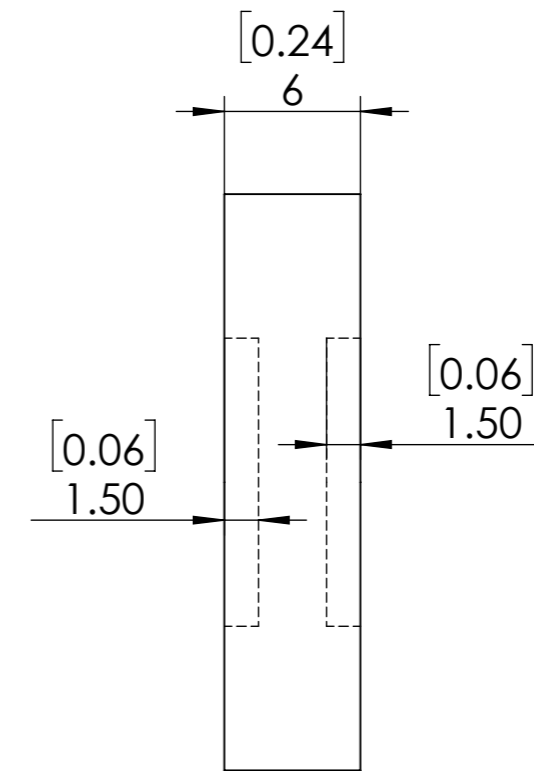
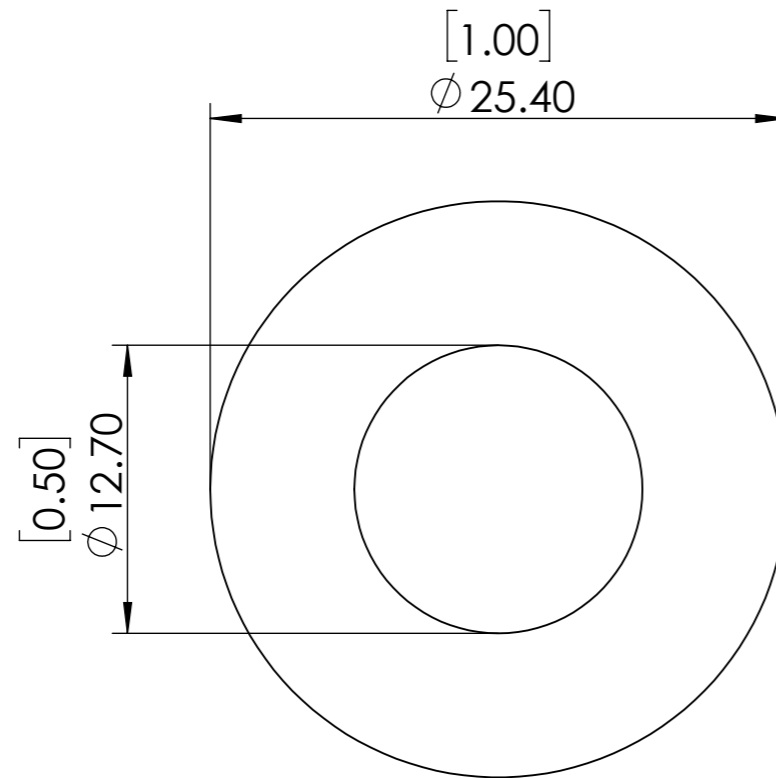
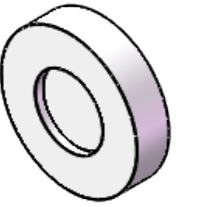

1. UNMOUNTED DIAMETER: 12.7 mm
2. DESIGN WAVELENGTH: 780 nm
3. RETARDATION: $\lambda/4$
4. RETARDATION TOLERANCE: $<\lambda/300$
5. WAVEFRONT DISTORTION: $<\lambda/8@633\text{nm}$
6. SURFACE QUALITY: 20/10
7. CLEAR APERTURE: $>11.5\text{mm}$
8. PARALLELISM: <1 arcsec
9. COATING: $R<0.25\%@780\text{nm}$

SIMTRUM www.simtrum.com	
Title:	Cemented True Zero Order Quarter Waveplate
Material:	Quartz/BK7
Part No:	QB-CTZQWP-12.7-780-M