

**FOR INFORMATION ONLY
NOT FOR MANUFACTURING PURPOSES**

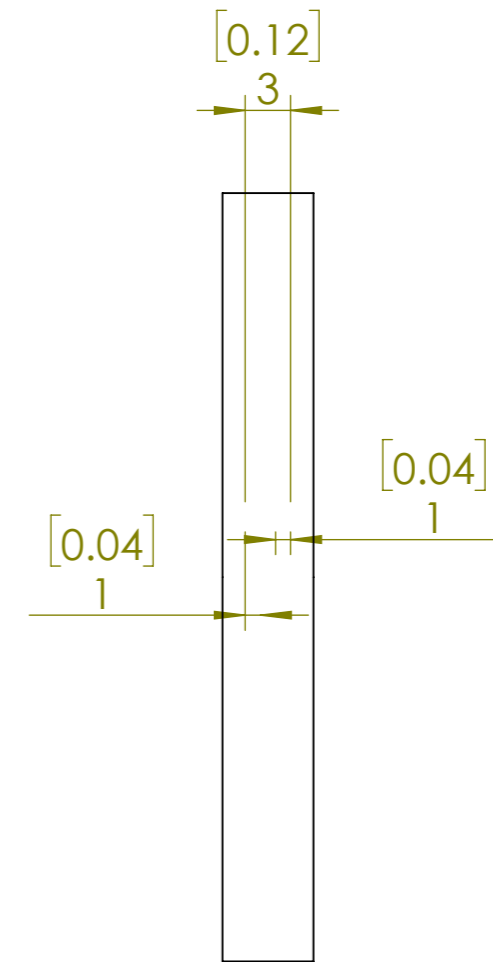
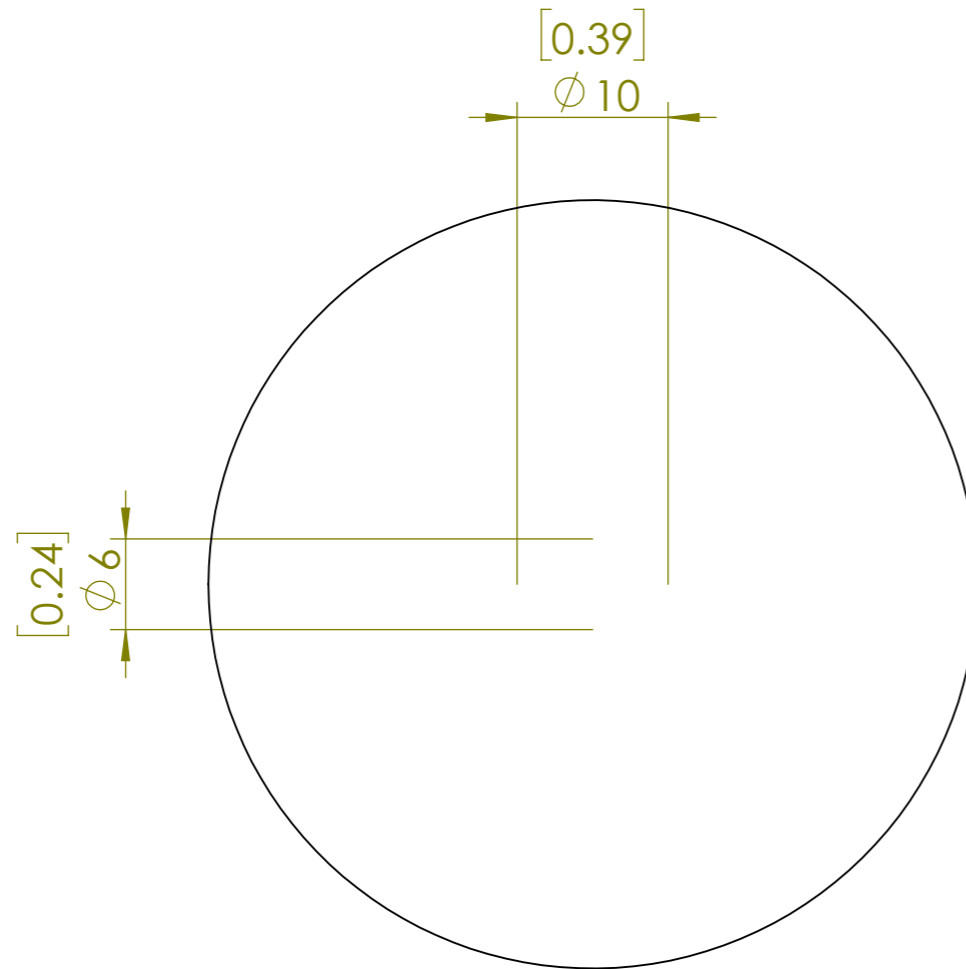
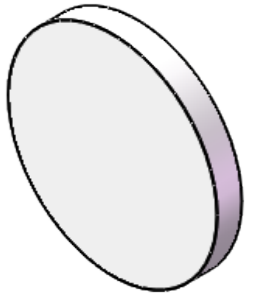

1. UNMOUNTED DIAMETER: 50.8
2. DESIGN WAVELENGTH: 852 nm
3. RETARDATION: $\lambda/2$
4. RETARDATION TOLERANCE: $<\lambda/300$
5. WAVEFRONT DISTORTION: $<\lambda/8@633\text{nm}$
6. SURFACE QUALITY: 20/10
7. CLEAR APERTURE: $>45.0\text{mm}$
8. PARALLELISM: <1 arcsec
9. COATING: $R<0.25\%$ @852nm

SIMTRUM www.simtrum.com	
Title:	Cemented True Zero Order Half Waveplate
Material:	Quartz/BK7
Part No:	QB-CTZHWP-50.8-852-M