

**FOR INFORMATION ONLY
NOT FOR MANUFACTURING
PURPOSES**

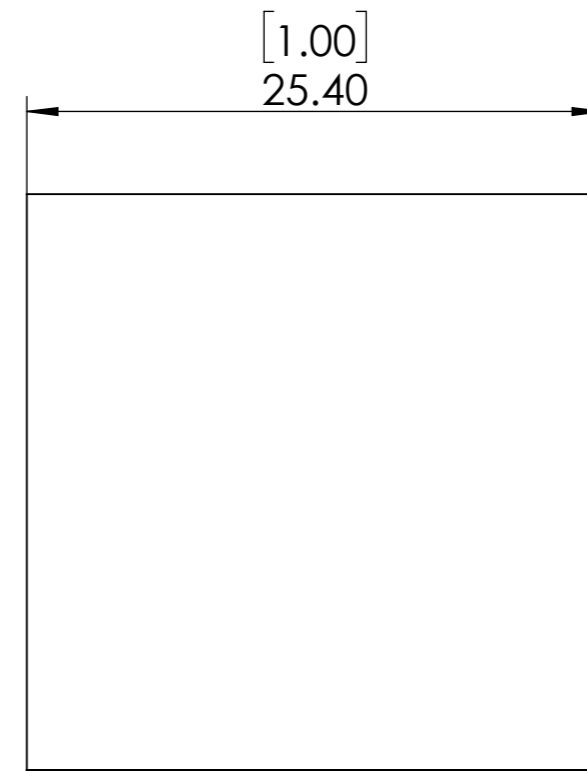
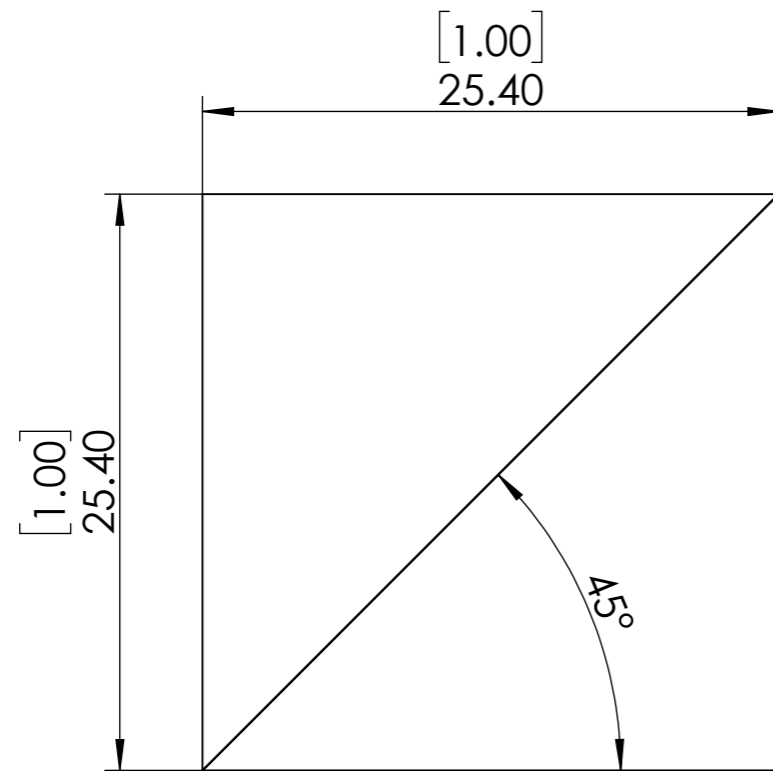
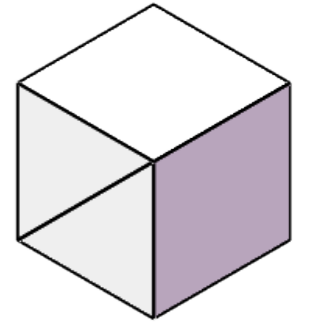

- 1.CLEAR APERTURE: >90%
- 2.SURFACE FLATNESS: < $\lambda/4$ @633nm
- 3.SURFACE QUALITY: 40-20
- 4.AOI: 0 deg
- 5.SPLIT RATIO:50:50%
- 6.POLARIZATION: $T=(T_s+T_p)/2$ $R=(R_s+R_p)/2$
- 7.TRANSMITTED BEAM DEVIATION: <3 arcmin
- 8.REFLECTED BEAM DEVIATION: <3 arcmin
- 9.DIMENSION TOLERANCE: ± 0.2 mm
- 10.T/R TOLERANCE: $\pm 5\%$, $T=(T_s+T_p)/2$, $R=(R_s+R_p)/2$
- 11.COATING: $R_{avg} < 0.5\%$ @ 400-700nm

SIMTRUM www.simtrum.com	
Title:	Polarization dependent beamsplitter cubes
Material:	BK7
Part No:	BK7-BSC-25.4-400-700