

**FOR INFORMATION ONLY NOT FOR  
MANUFACTURING PURPOSES**

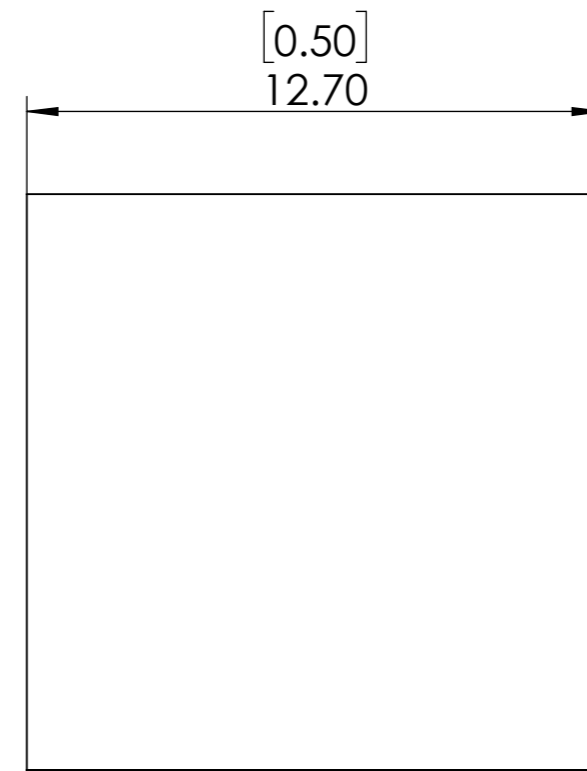
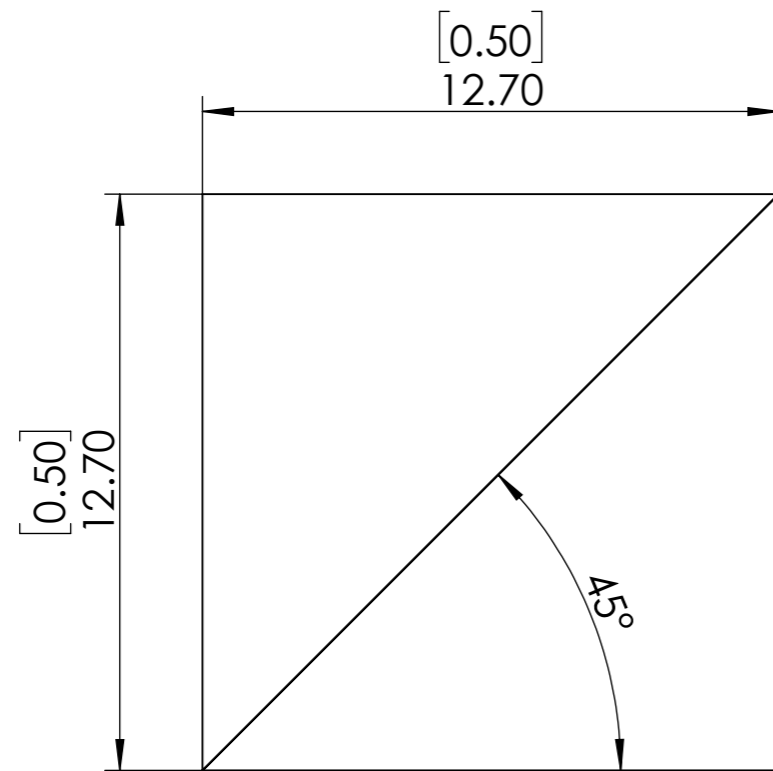
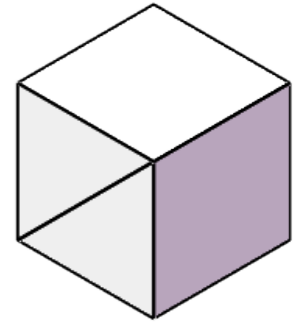

- 1.CLEAR APERTURE: >90%
- 2.SURFACE FLATNESS: < $\lambda/4$ @633nm
- 3.SURFACE QUALITY: 40-20
- 4.AOI: 0 degree
- 5.SPLIT RATIO: 45:45 $\pm$ 5%
- 6.POLARIZATION: |Rs-Rp| <6%, |Ts-Tp| <6%
- 7.TRANSMITTED BEAM DEVIATION: <3 arcmin
- 8.REFLECTED BEAM DEVIATION: <3 arcmin
- 9.DIMENSION TOLERANCE: $\pm$  0.2 mm
- 10.COATING:Ravg < 0.5% @ 650-900nm

<b>SIMTRUM</b> <a href="http://www.simtrum.com">www.simtrum.com</a>	
Title:	Broadband Non-Polarizing Beamsplitter Cubes
Material:	BK7
Part No:	BK7-NPBSC-12.7-650-900