

**FOR INFORMATION ONLY NOT FOR  
MANUFACTURING PURPOSES**

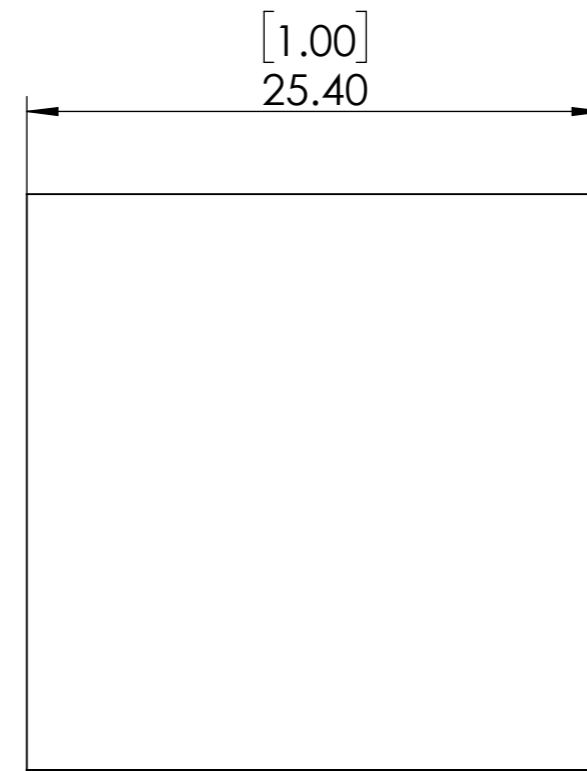
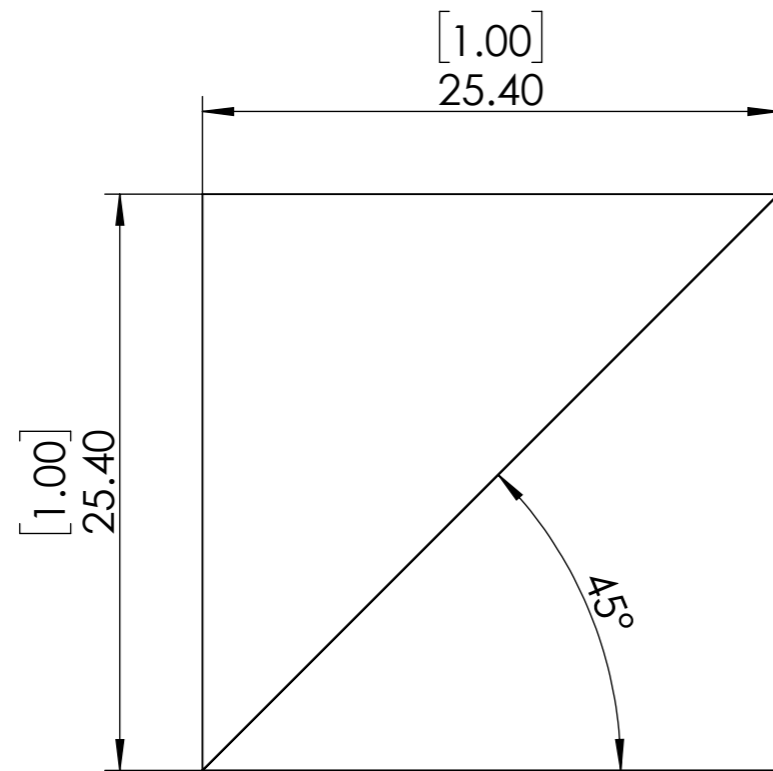
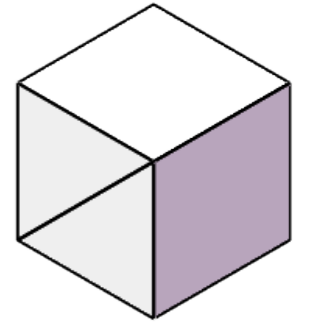

- 1.CLEAR APERTURE: >90%
- 2.SURFACE FLATNESS:  $<\lambda/4@633\text{nm}$
- 3.SURFACE QUALITY: 40-20
- 4.AOI: 0 degree
- 5.SPLIT RATIO: 45:45±5%
- 6.POLARIZATION:  $|R_s-R_p| < 6\%$ ,  $|T_s-T_p| < 6\%$
- 7.TRANSMITTED BEAM DEVIATION:  $<3$  arcmin
- 8.REFLECTED BEAM DEVIATION:  $<3$  arcmin
- 9.DIMENSION TOLERANCE:  $\pm 0.2$  mm
- 10.COATING:  $R_{\text{avg}} < 0.5\%$  @ 450-650nm

<b>SIMTRUM</b> <a href="http://www.simtrum.com">www.simtrum.com</a>	
Title:	Broadband Non-Polarizing Beamsplitter Cubes
Material:	BK7
Part No:	BK7-NPBSC-25.4-450-650