

**FOR INFORMATION ONLY
NOT FOR MANUFACTURING PURPOSES**

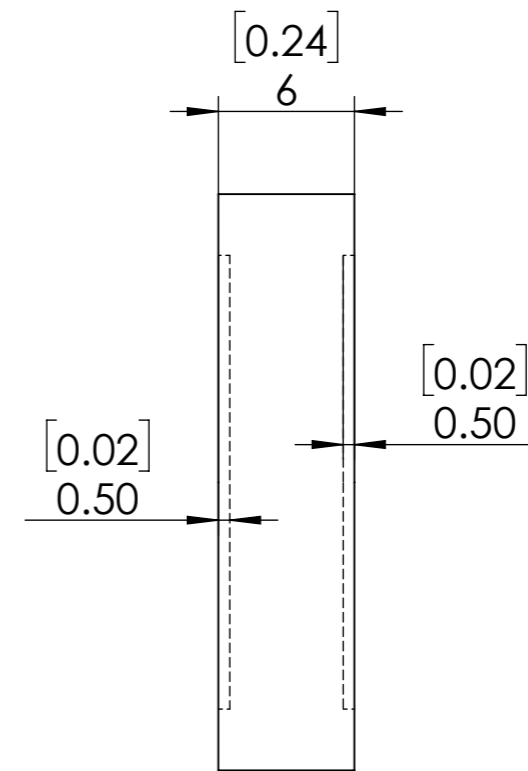
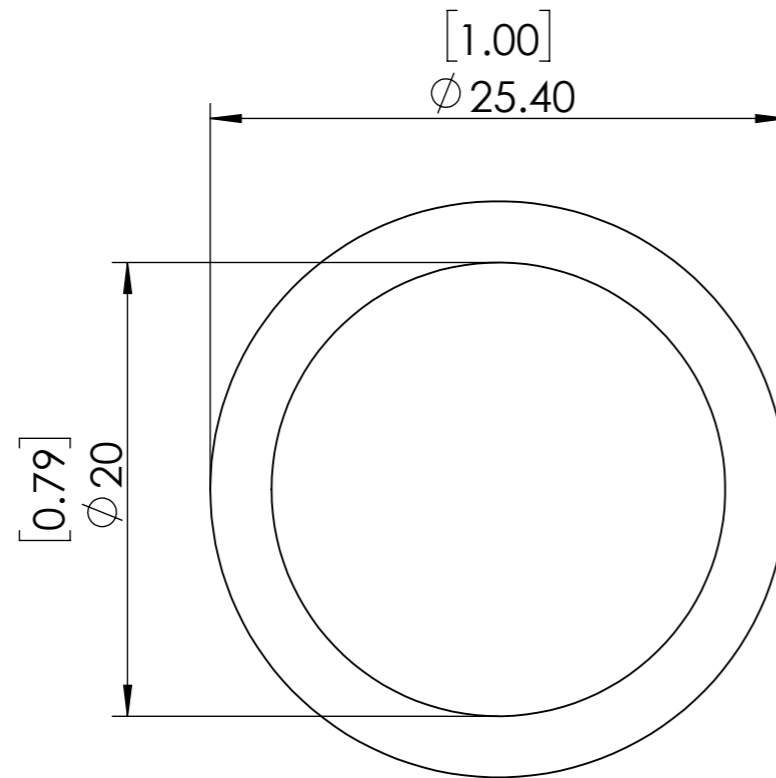
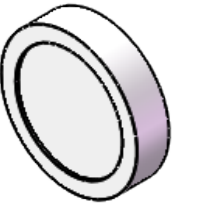

1. UNMOUNTED DIAMETER: 20
2. DESIGN WAVELENGTH: 532+1064 nm
3. RETARDATION: $\lambda/2@1064\text{nm}+\lambda/4@532\text{nm}$
4. RETARDATION TOLERANCE: $<\lambda/100$
5. WAVEFRONT DISTORTION: $<\lambda/8@633\text{nm}$
6. SURFACE QUALITY: 20/10
7. CLEAR APERTURE: $>18.0\text{mm}$
8. PARALLELISM: <1 arcsec
9. COATING: $R<0.5\%@532+1064\text{nm}$

SIMTRUM www.simtrum.com	
Title:	Zero Order Dual Wavelength Waveplate
Material:	Quartz
Part No:	Q-ZDWWP-R24-20-1064-SHM