

**FOR INFORMATION ONLY  
NOT FOR MANUFACTURING PURPOSES**

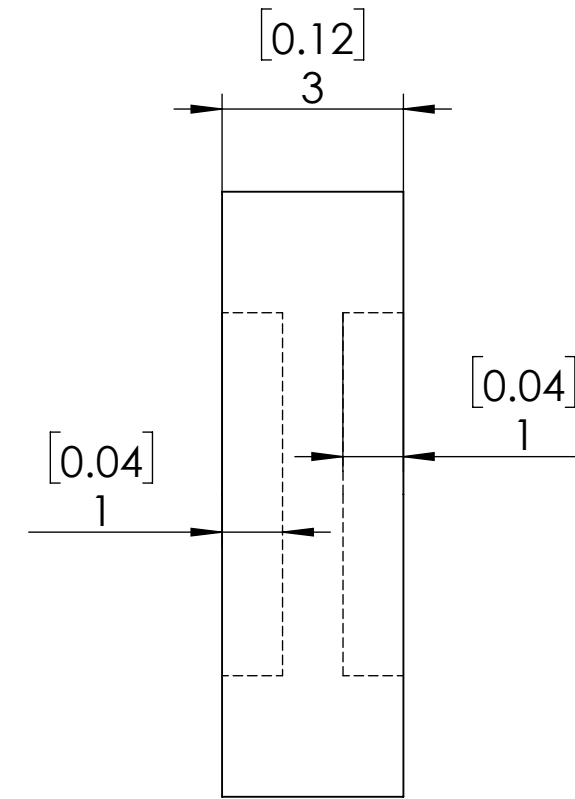
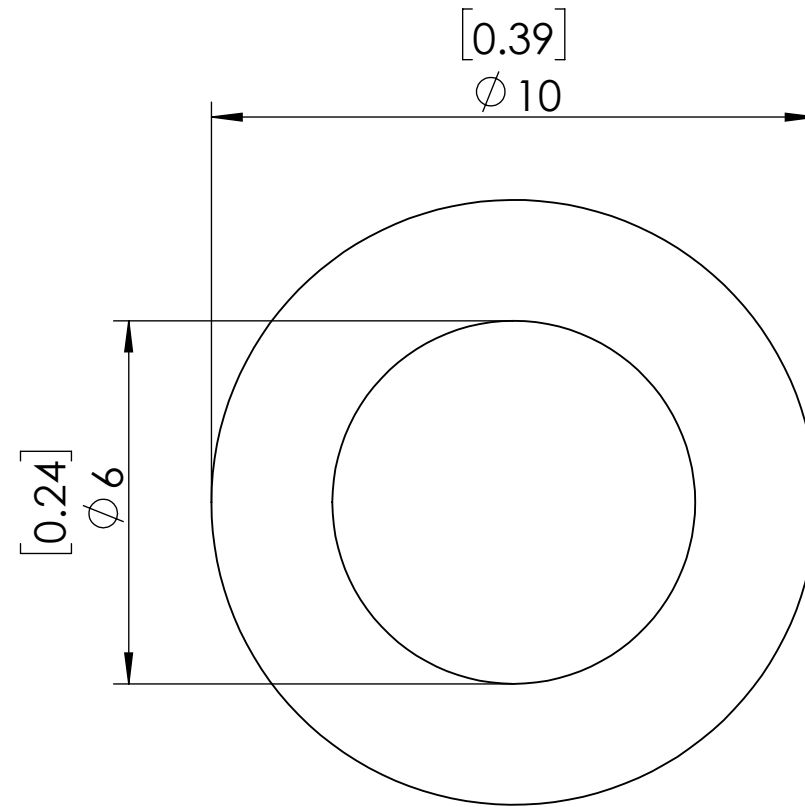
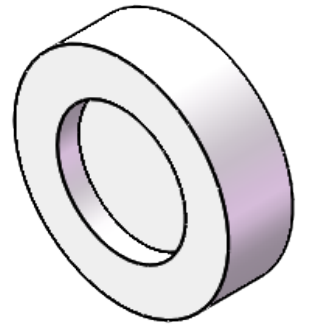

1. UNMOUNTED DIAMETER: 25.4
2. DESIGN WAVELENGTH: 532+1064 nm
3. RETARDATION:  $\lambda/2@1064\text{nm}+\lambda@532\text{nm}$
4. RETARDATION TOLERANCE:  $<\lambda/100$
5. WAVEFRONT DISTORTION:  $<\lambda/8@633\text{nm}$
6. SURFACE QUALITY: 20/10
7. CLEAR APERTURE:  $>22.9\text{mm}$
8. PARALLELISM:  $<1$  arcsec
9. COATING:  $R<0.5\%@532+1064\text{nm}$

<b>SIMTRUM</b> www.simtrum.com	
Title:	Dual Wavelength Waveplate
Material:	Quartz
Part No:	Q-DWWP-R21-25.4-1064-SH-M