

**FOR INFORMATION ONLY
NOT FOR MANUFACTURING PURPOSES**

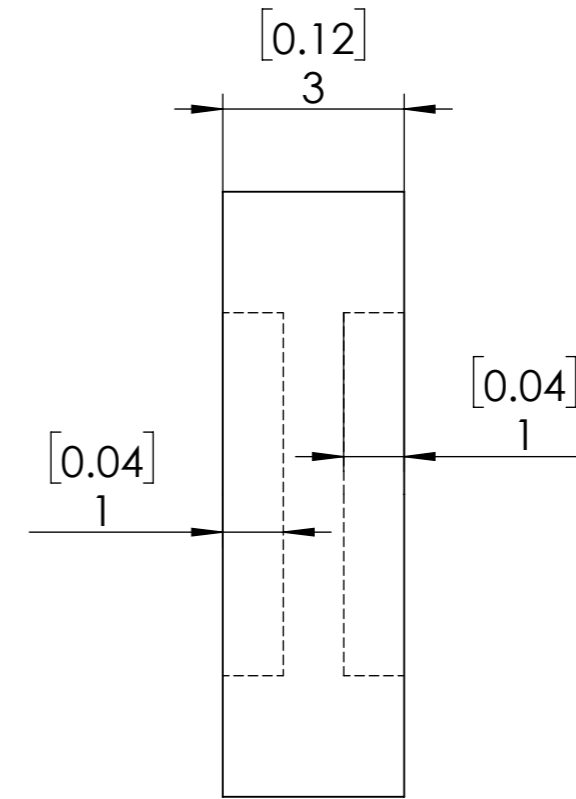
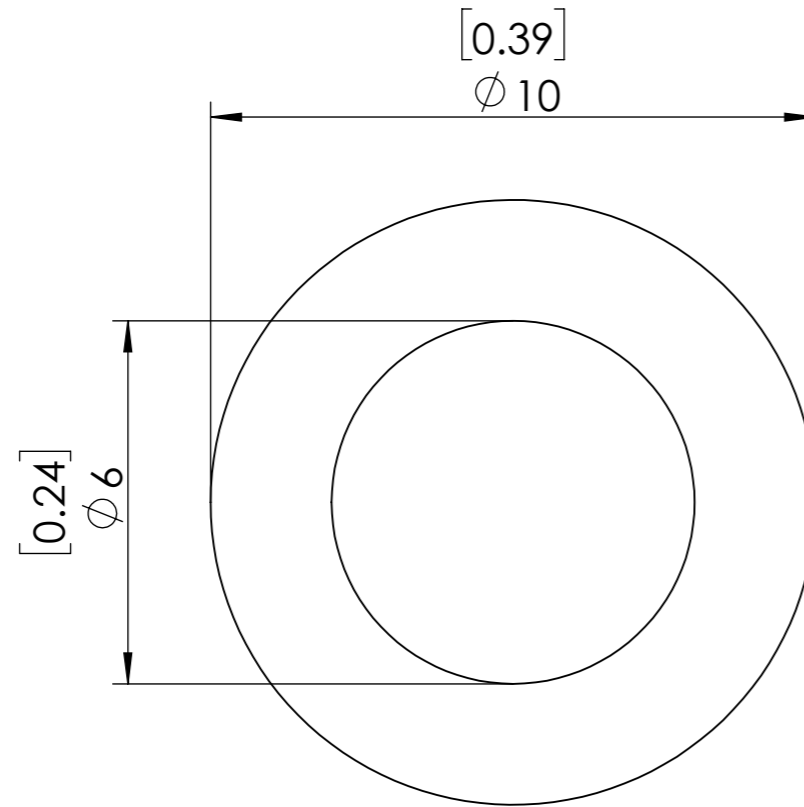
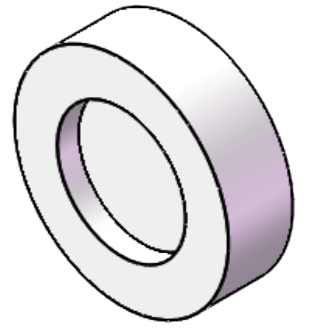

1. UNMOUNTED DIAMETER: 12.7
2. DESIGN WAVELENGTH: 532+1064 nm
3. RETARDATION: $\lambda/4@1064\text{nm}+\lambda/2@532\text{nm}$
4. RETARDATION TOLERANCE: $<\lambda/100$
5. WAVEFRONT DISTORTION: $<\lambda/8@633\text{nm}$
6. SURFACE QUALITY: 20/10
7. CLEAR APERTURE: $>11.5\text{mm}$
8. PARALLELISM: <1 arcsec
9. COATING: $R<0.5\%@532+1064\text{nm}$

SIMTRUM www.simtrum.com	
Title:	Dual Wavelength Waveplate
Material:	Quartz
Part No:	Q-DWWP-R42-12.7-1064-SH-M