

Copyright © Tucsens Photoelectric Co., Ltd. , All rights reserved.

This guide is for information purposes only and does not constitute any commitment.

If there is inconsistency between the image and the actual product, the actual product shall govern.



[www.tucsen.com](http://www.tucsen.com)

# Dhyana sCMOS camera Quick Start



# Content

|  |    |
|--|----|
| 1. Instructions of camera -----              | 01 |
| 2. Camera interface description -----        | 03 |
| 3. Water-cooled interface installation ----- | 09 |
| 4. Data interface installation -----         | 13 |
| 5. Driver installation -----                 | 14 |
| 6. Software installation -----               | 16 |
| 7. Maintenance -----                         | 17 |
| 8. Warranty service -----                    | 18 |
| 9. After-sale support -----                  | 19 |

# 1. Instructions of camera

| Dhyana 400BSI V2   | Dhyana 95 V2  | Dhyana 4040   |
|--|---|---|
|   |    |    |
| <b>Key features</b>  |   |   |
| 1.2" sensor size<br>6.5um pixel size<br>4 MP resolution<br>Up to 95% QE<br>C-mount<br>USB3.0 interface<br>CameraLink interface<br>SMA trigger interface<br>Air cooling / Water cooling<br>Monochrome | 2" sensor size<br>11um pixel size<br>4 MP resolution<br>Up to 95% QE<br>T-mount / C-mount / F-mount<br>USB3.0 interface<br>CameraLink interface<br>SMA trigger interface<br>Air cooling / Water cooling<br>Monochrome | 3.2" sensor size<br>9um pixel size<br>16 MP resolution<br>Up to 74% QE<br>F-mount / C-mount<br>USB3.0 interface<br>CameraLink interface<br>SMA trigger interface<br>Air cooling<br>Monochrome |
| <b>Standard list</b>   |   |   |
| 1x camera<br>1x power cord<br>1x power adapter<br>1x USB3.0 cable<br>1x software ( U disk )<br>2x water-cooled pipe*<br>1x CameraLink frame grabber*<br>2x CameraLink cable*                         | 1x camera<br>1x power cord<br>1x power adapter<br>1x USB3.0 cable<br>1x software ( U disk )<br>1x F-mount<br>2x water-cooled pipe*<br>1x CameraLink frame grabber*<br>2x CameraLink cable*                            | 1x camera<br>1x power cord<br>1x power adapter<br>1x USB3.0 cable<br>1x software ( U disk )<br>1x CameraLink frame grabber*<br>2x CameraLink cable*   |

Note : \*means optional

| Dhyana 400D  | Dhyana 400DC   | Dhyana 401D/201D   |
|--|--|--|
|   |   |   |
| <b>Key features</b>  |  |  |
| 1.2" sensor size<br>6.5um pixel size<br>4 MP resolution<br>Up to 80% QE<br>C-mount<br>USB3.0 interface<br>SMA trigger interface<br>Air cooling<br>Monochrome | 1.2" sensor size<br>6.5um pixel size<br>4 MP resolution<br>C-mount<br>USB3.0 interface<br>HIROSE trigger interface<br>Air cooling<br>Color | 1.2" / 1" sensor size<br>6.5um pixel size<br>4 MP / 2 MP resolution<br>C-mount<br>USB3.0 interface<br>HIROSE trigger interface<br>Monochrome |
| <b>Standard list</b>   |  |  |
| 1x camera<br>1x power cord<br>1x power adapter<br>1x USB3.0 cable<br>1x software ( U disk )<br>2x cross-screw  | 1x camera<br>1x power cord<br>1x power adapter<br>1x USB3.0 cable<br>1x software ( U disk )<br>2x cross-screw                              | 1x camera<br>1x USB3.0 cable<br>1x software ( U disk )   |

## 2. Camera interface description

### Dhyana 95 V2

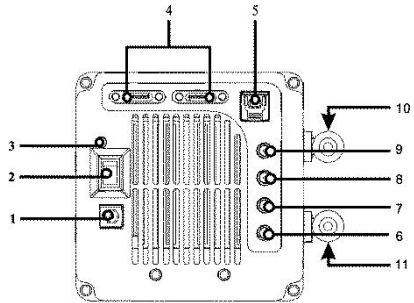

| Serial No.       | Part name            | Function                                       |
|------------------|----------------------|--|
| 1                | DC12V/8A             | Power supply                                   |
| 2                | Switch               | Control camera power                           |
| 3                | LED indicator        | Indicates if the camera is working             |
| 4                | Cameralink interface | Camera data transmission                       |
| 5                | USB 3.0              | Camera data transmission                       |
| 6                | TRIG.IN              | External trigger signal input (SMA interface)  |
| TRIG.OUT (7/8/9) |                      | External trigger signal output (SMA interface) |
| 7                | TRIG.OUT3            | Exposure start signal                          |
| 8                | TRIG.OUT2            | Global exposure signal                         |
| 9                | TRIG.OUT1            | Image readout signal                           |
| 10               | Water connector 1    | water cooling                                  |
| 11               | Water connector 2    | water cooling                                  |

### Dhyana 4040

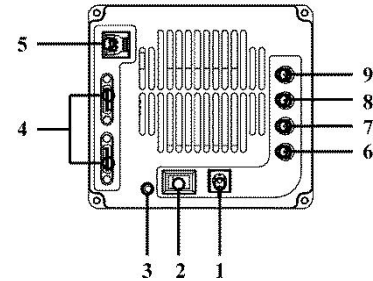

| Serial No.       | Part name            | Function                                       |
|------------------|----------------------|--|
| 1                | DC12V/8A             | Power supply                                   |
| 2                | Switch               | Control camera power                           |
| 3                | LED indicator        | Indicates if the camera is working             |
| 4                | Cameralink interface | Camera data transmission                       |
| 5                | USB 3.0              | Camera data transmission                       |
| 6                | TRIG.IN              | External trigger signal input (SMA interface)  |
| TRIG.OUT (7/8/9) |                      | External trigger signal output (SMA interface) |
| 7                | TRIG.OUT3            | Exposure start signal                          |
| 8                | TRIG.OUT2            | Global exposure signal                         |
| 9                | TRIG.OUT1            | Image readout signal                           |

## 2. Camera interface description

### Dhyana 400BSI V2

Data interface

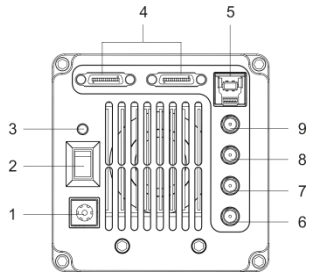

Water-cooled interface

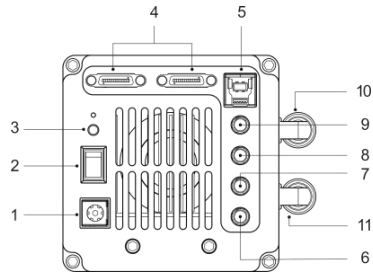

| Serial No.       | Part name            | Function                                       |
|------------------|----------------------|--|
| 1                | DC12V/8A             | Power supply                                   |
| 2                | Switch               | Control camera power                           |
| 3                | LED indicator        | Indicates if the camera is working             |
| 4                | Cameralink interface | Camera data transmission                       |
| 5                | USB 3.0              | Camera data transmission                       |
| 6                | TRIG.IN              | External trigger signal input (SMA interface)  |
| TRIG.OUT (7/8/9) |                      | External trigger signal output (SMA interface) |
| 7                | TRIG.OUT3            | Exposure start signal                          |
| 8                | TRIG.OUT2            | Global exposure signal                         |
| 9                | TRIG.OUT1            | Image readout signal                           |
| 10               | Water connector 1    | water cooling                                  |
| 11               | Water connector 2    | water cooling                                  |

### Dhyana 95 / Dhyana 400BSI / Dhyana 400D

Data interface

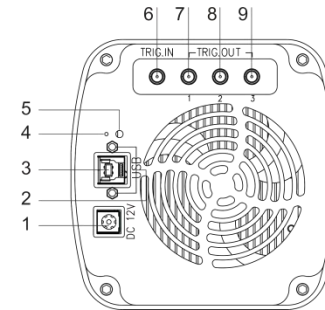

| Serial No.       | Part name             | Function                                       |
|------------------|-----------------------|--|
| 1                | DC12V/8A              | Power supply                                   |
| 2                | USB fixed hole        | Fixed USB 3.0 data cable                       |
| 3                | USB3.0 interface      | Camera data transmission                       |
| 4                | Online upgrade button | Upgrade the firmware                           |
| 5                | LED indicator         | Indicates if the camera is working             |
| 6                | TRIG.IN               | External trigger signal input (SMA interface)  |
| TRIG.OUT (7/8/9) |                       | External trigger signal output (SMA interface) |
| 7                | TRIG.OUT1             | Image readout signal                           |
| 8                | TRIG.OUT2             | Global exposure signal                         |
| 9                | TRIG.OUT3             | Exposure start signal                          |

## 2. Camera interface description

### Dhyana 400DC

Data interface

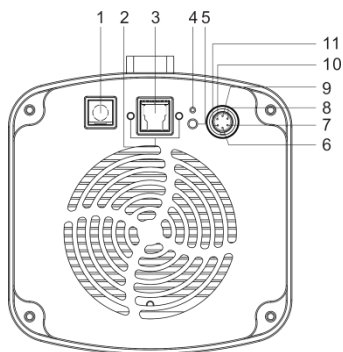

| Serial No. | Part name             | Function   |
|------------|-----------------------|--|
| 1          | DC12V/8A              | Power supply                                     |
| 2          | USB fixed hole        | Fixed USB 3.0 data cable                         |
| 3          | USB3.0 interface      | Camera data transmission                         |
| 4          | Online upgrade button | Upgrade the firmware                             |
| 5          | LED indicator         | Indicates if the camera is working               |
| 6          | TRIG.IN               | External trigger signal input (HIROSE interface) |
| 7          | TRI_IN_GND            | GND  |
| 8          | TRI_OUT_GND           | GND  |
| 9          | TRIG.OUT0             | Image readout signal                             |
| 10         | TRIG.OUT1             | Global exposure signal                           |
| 11         | TRIG.OUT2             | Exposure start signal                            |

### Dhyana 401D/201D

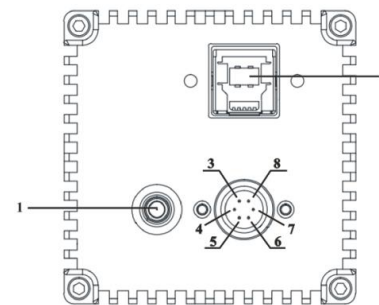

| Serial No. | Part name              | Function                           |
|------------|------------------------|------------------------------------|
| 1          | LED indicator          | Indicates if the camera is working |
| 2          | USB3.0 interface       | Camera data transmission           |
| 3          | TRI_IN (Standard mode) | External trigger signal input      |
| 4          | TRI_GND TRI            | GND                                |
| 5          | NC                     | /                                  |
| 6          | TRI_OUT0               | Exposure start signal              |
| 7          | TRI_OUT1               | Readout end signal                 |
| 8          | NC                     | /                                  |

### 3. Water-cooled interface installation

Currently only Dhyana 400BSI V2 and Dhyana 95 V2 offer water-cooled mode , Installation schematic diagram is as follows

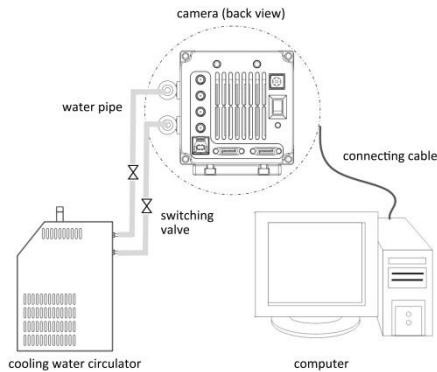

#### 3.1 Installation procedure of water-cooled pipe

- 1、 Place the camera on a smooth workbench
- 2、 Connect water-cooled pipe to the water pipe connector on the camera and make sure it is inserted in place as shown below ( pipe specification : inner①5mm , outerΦ8mm).

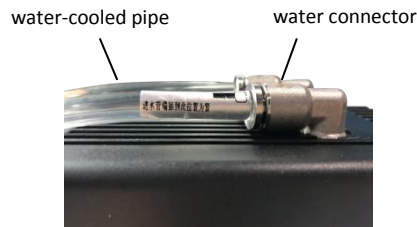

- 3、 Insert the water pipe into the nozzle of the cooling water circulator and lock it with clamps.
- 4、 Connet the water pipes of cooling water circulator and camera via switching valve.

#### 3.2 Disconnect procedures of water-cooled pipe

- 1、 Disconnect power for camera and all other equipments including the circulating water cooler.
- 2、 According to the instructions of cooling water circulator, unplug its water pipe and discharge the water inside.
- 3、 Press the slide sleeve of switching valve to pull out the water pipe of cooling water circulator and discharge the water inside.
- 4、 Press the water connector to pull out the camera water pipe. First, turn the side with installed water valve to the side (not the top). When pulling out the water pipe, the water valve orifice is facing down. Protect with a absorbent towel or tissue to ensure no water leaking into the camera (as shown below)

Water valve sliding sleeve



Note :

After the water pipe is pulled out, a small amount of water remains in the camera water valve. Please carefully pour the water out with the valve orifice down.

### 3.3 Installation precautions

#### 1、 switching the cooling mode

The camera's default cooling mode is air-cooled. You can switch into water-cooled by adjusting the fan gear. Every time you select fan Off, you will be prompted as follows: click OK to close the fan

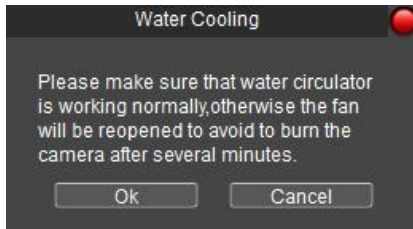

#### 2、 Cooling water selection: bottled water is recommended.

3、 Water temperature : The water temperature in circulator is recommended to be 20°C.

4、 Install water-cooled pipe correctly to ensure no water seepage at the interfaces between the camera end and the circulator.

5、 Before the operation of the camera, ensure that the installation of circulator and camera water valve is correct, and the water flow in the water pipe reaches 1L/min.

6、 Cooling water circulator : Use the circulator and cooled water correctly according to its instructions

7、 According to the experimental data, condensation water will occur in water valves and water pipes under inappropriate environmental conditions, and there is a potential risk of damage to the equipment. In order to ensure the normal operation of the equipment, the following provisions are made on the ambient temperature and humidity (refer to the figure below).

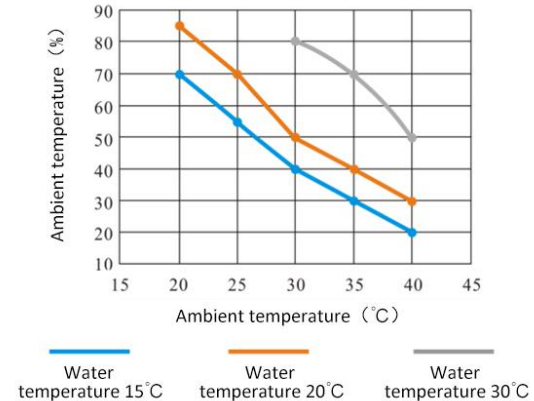

8、 During the operation of the camera, do not turn off the cooling water circulator and stop the refrigeration.

9、 After the operation, turn off the power of the camera and the circulator, and drain their water.

Warning :

Water-cooled and fan can be turned on at the same time, but not turned off at the same time. At least ensure it is in operation with one cooling mode. Otherwise, the sensor may be damaged by continuous high temperature operation



## 4. Data interface installation

### USB interface

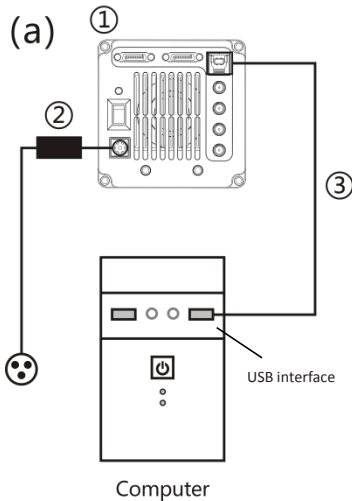

### Cameralink interface

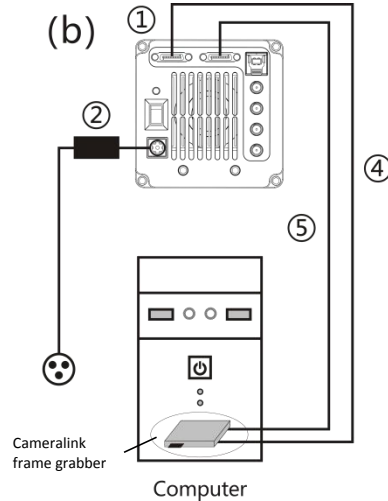

- ① Dhyana camera      ② power adapter      ③ USB 3.0 cable  
 ④ CameraLink cable 1      ⑤ Cameralink cable2

#### Precautions :

- (1) USB3.0 interface should be connected to the back end of the host computer, blue or USB interface with SS logo ;
- (2) Dhyana 95/400BSI V1/400D/400DC only support USB3.0 ;
- (3) Dhyana 400BSI V2, Dhyana 95 V2 and Dhyana 4040 support both USB3.0 and Cameralink ;
- (4) When USB3.0 and cameralink interfaces are connected at the same time, the default is USB3.0 interface.

## 5. Driver Installation

### 5.1 Recommended system configuration

| Interface | USB 3.0            | CameraLink           |
|-----------|--------------------|----------------------|
| PC        | XeonE5-2640(CPU)   | HP Z820 workstations |
| System    | Windows 7/10 64bit | Windows 7/10 64bit   |
| Memory    | 8GB or more        | 32GB or more         |

### 5.2 The driver installation of USB 3.0

Connect the camera to the PC. Opening the U disk comes with the camera, operate the .exe file and follow the [Next] button to [finish] the installation.

After the installation, open the Device Manager and check whether the driver is installed properly. If there is NO YELLOW FLAG with the camera under Imaging Devices in Device Manager, the driver is installed successfully, as shown below. If the YELLOW FLAG occurred, you need to reinstall the driver.



### 5.3 The driver Installation of CameraLink

Turn off the computer and open the cover of the host. Select the appropriate PCIe slot (Bandwidth is more than 850 MB/s) to insert the CameraLink frame grabber. Secure the computer with a screw and then restart the computer. Connect the camera to the interface of the computer's frame grabber via two Cameralink cable.

| PCIe | x1      | x4      | x8      | x16      |
|------|---------|---------|---------|----------|
| 1.0  | 250MB/s | 1GB/s   | 2GB/s   | 4GB/s    |
| 2.0  | 500MB/s | 2GB/s   | 4GB/s   | 8GB/s    |
| 3.0  | 985MB/s | 3.9GB/s | 7.8GB/s | 15.7GB/s |

Connect the camera to the PC after successfully installing the CameraLink grabber. Open the U disk which comes with the camera, double click the cameralink driver and follow the [Next] button to [finish] the installation.

After the camera Cameralink driver is installed, open the Device Manager of your computer. When the driver is successfully installed, the Cameralink frame grabber will appear under Device Manager, as shown below.



### 6. Software Installation

6.1. Double-click the software to start the installation and follow the [Next] button to finish the installation.

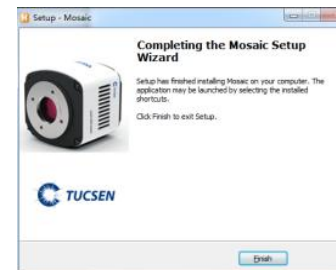

6.2. After finish the installation, software shortcut will be created on the desktop.

Note: If previous version Mosaic was installed in your PC, the installer will automatically detect it and ask to remove it first before install the new one. If the previous installed Mosaic is still running, it will ask to close the software and then start the installation.

6.3. Double-click the Mosaic shortcut to start the software.  Software will auto detect the device and start the preview. The status bar will display the version number of the software, the camera model, and the current real-time frame rate.



Note: If camera connect correctly, the software will automatic identify camera and enter pre-view status during startup .If get software error,it could be the camera is not detected by the PC or the driver is not installed properly. Please reinstall the driver.

## 7. Maintenance

1. Avoid removing the lens cap in a dusty environment.
2. When removing the lens cap or mounting a lens, hold the camera face down to prevent dust from falling on the sensor surface.
3. When the camera is not being used, the lens cap should be replaced.
4. Use a professional dust removal tool to remove any dust on the camera optical filter.
  - If dust gets on the filter, it should be removed using low pressure air.
  - For stubborn oily dust, the surface can be gently wiped using a lint-free cotton swab dipped in ethanol.
5. If it still cannot be cleaned, contact the after-sales personnel for assistance. The use of non-professional equipment for cleaning is prone to lead to scratches on the filter surface.
6. If the camera has been stored in a low temperature environment, allow the camera to gradually warm up before use, because otherwise condensation may form on the optics and electronics.
7. Use only the original power adapter. Ensure the adapter and associated cables are free from items that may cause damage. If the power adapter is damaged, please contact the supplier for an immediate replacement.
8. In event that the adaptor appears to be operating abnormally, cut off the adaptor power supply immediately in order to avoid damage to the camera.
9. The camera has been designed for external triggering functions, that can be activated via an external connector. Consult the supplier if you require additional information regarding these functions.

## 8. Warranty service

Tucsen carries out two years of free warranty service, warranty starts from the date of product acceptance. Except for the special provisions of the contract, 7 days after the receipt of goods without doubt is considered to be qualified acceptance. Man-made product quality problems are not within the scope of warranty. After warranty period, Tucsen implements lifetime maintenance policy, and only a certain material cost is charged for product maintenance.



Do not disassemble

Do not disassemble, repair or modify on your own. Otherwise it will cause damage to the camera chip or devices on the circuit board.



Do not contact water

Avoid allowing the camera to get wet, since this may cause the failures such as circuit board device corrosion, burnout and so on.



Do not subject the camera to physical shock

Avoid physical impacts such as dropping or banging.



Immediate repair request

Unplug the data cable and the power supply then request TUCSEN to have the authorized dealer or sales for repair.

## 9. After-sales support

1. Obtain software-related information and technical support information from the official website [support] -> [FAQ].

2. Contact technical support:

·TEL: +86-591-88194580-811

·Email: [service@tucsen.com](mailto:service@tucsen.com)

·Or landing the official website to leave a message: <http://www.tucsen.com>,

please have the following information prepared:

1)Camera model and S/N (product serial number);

2)Software version number and system information;

3)Description of the problem and any images related to the problem.